



Pro Scale® Lighting Installation Kit - Mercedes® G 500® & G 63® Covers Part #8893

Kit contents:

- Distribution block mount (1)
- Turn signal harness (1)
- Reverse light harness (1)
- Rear fog light harness (1)
- Jumper (1)
- Reverse light lens (right) (1)
- Rear fog light lens (left) (1)
- 2.6x8mm button-head cap screws (4)
- 2.5x8mm button-head cap screws (4)
- Zip ties (5)

Tools required:

- 1.5mm hex wrench
- 2.0mm hex wrench
- Body scissors (part #3431 or #3432, sold separately)

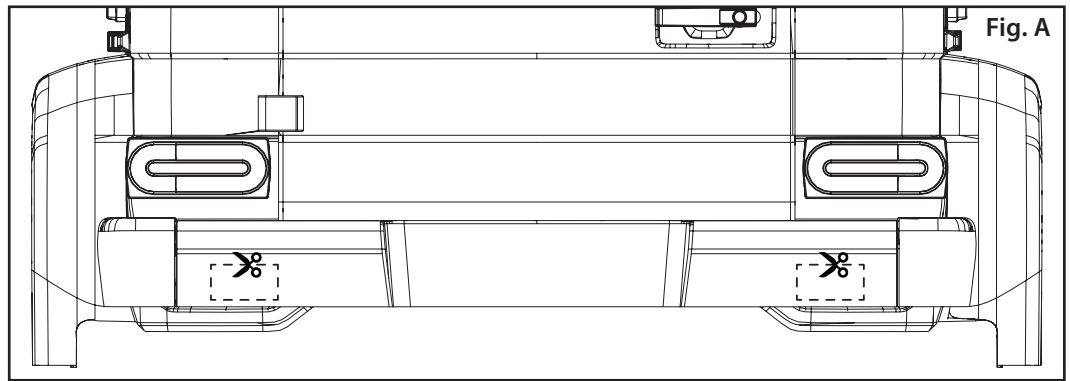

CAUTION: RISK OF INJURY!

Use care with hobby knives, tapered reamers, and other cutting tools as they are extremely sharp and can cause severe injury, deep cuts, and/or punctures.

Body modification

The vehicle body will need modification for installation of the reverse light and rear fog light on the rear bumper. Use Lexan® body scissors or a hobby knife to cut out the sections as indicated in Fig. A. Follow the lines molded into the body.

Installation

This kit contains the installation components necessary to adapt the part #8898 Mercedes® G 500®/G 63® LED Light Kit for full compatibility with the Pro Scale Advanced Lighting Control system, part #6591 (part #8898 and 6591 sold separately).

If the 8898 LED light kit has already been installed, it will be necessary to remove the existing distribution block and mount in the body and install the new Pro Scale Lighting Distribution Block (part #6593, included with part #6591) using the new distribution block mount supplied with this kit. These instructions assume the 8898 LED Light Kit has already been installed.

If you are installing the 8898 LED light kit for the first time, then follow the instructions included with the LED light kit except use the Pro Scale Lighting Distribution Block along with the mounting bracket supplied with this kit.

In either case above, you will also install the turn signal harness supplied with this kit alongside the tail light harness in the body. You will also install the supplied reverse light and rear fog light harnesses on the chassis. See the wiring diagrams on the following pages for supplemental information.

1. Insert the included reverse light LED (harness labeled for Channel 8) and rear fog light LED (harness labeled for Channel 5) into the receptacles in the rear bumper. Fasten the clear reverse light lens (right side) and red rear fog light lens (left side) to the rear bumper using the included 2.5x8mm button-head cap screws (4) as shown in Fig. B.
2. Route the wires from the two harnesses through the wire retainer channel on the rear bumper (Fig. C) and to the Pro Scale Lighting Power Module on the chassis. New zip ties are provided to secure the wires. The zip ties do not need to be tight; allow some extra length for wire movement.
3. Plug the rear fog light harness into channel 5 and the reverse light harness into channel 8 on the Pro Scale Lighting Power Module (see Chassis Wiring Diagram on reverse side).
4. Remove the 2.6x8mm button-head screws (2) from the side trim retainer to remove the installed distribution block and mount from the vehicle body (Fig. D1).
5. Unplug the installed LED light wire harness connectors from the existing distribution block.
6. Disconnect the white turn signal jumper plugs on the headlights harness and remove the single green jumper from the roof lights harness (see Body Wiring Diagrams on pages 3 and 4).
7. Install the new distribution block mount and secure with the 2.6x8 mm button-head screws (2) from step 1 (Fig. D2).
8. Install the included rear turn signal light harness in the body; snap the LEDs into the receptacles in the tail light housing mounts. Route the wires alongside the tail light wiring harness (see Body Wiring Diagrams on pages 3 and 4). Use zip ties to secure the wiring to the body in the locations provided.
9. Plug the connectors from the LED light wire harnesses into the ports on the Pro Scale Distribution Block. Match the color band and/or letter indicator on the wire harnesses with the corresponding color/letter of each port on the distribution block (see chart below). Install the single jumper into port E on the distribution block.
10. Use the included 2.6x8mm button-head screws (2) to secure the distribution block to the mount (Fig. D2).

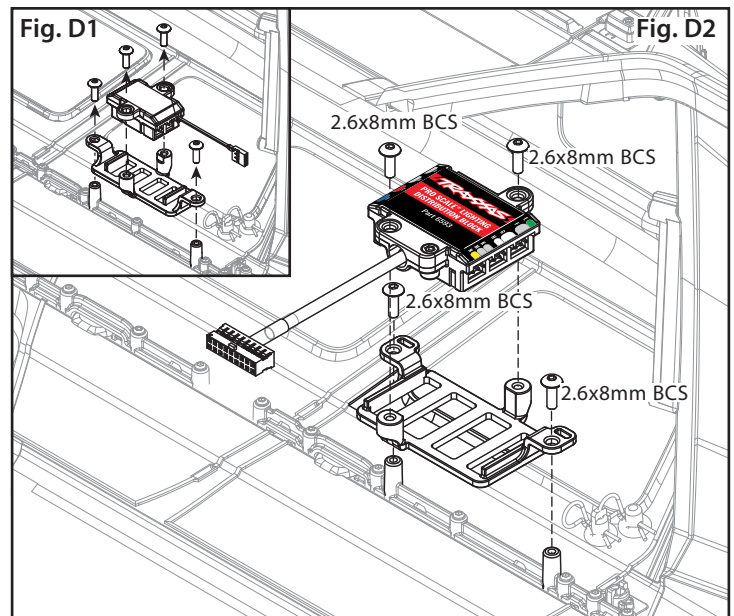
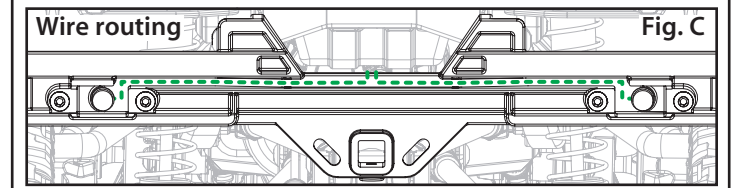
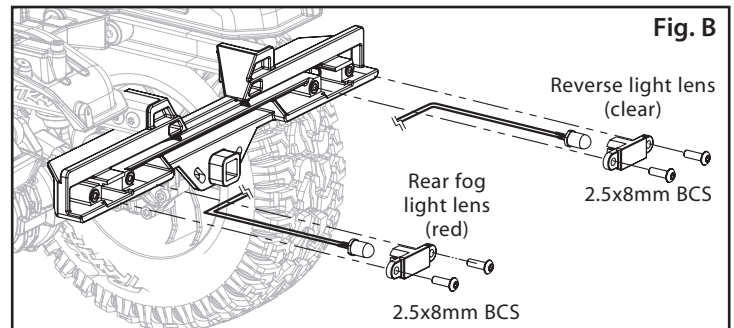

Distribution Block LED Light Harness Ports

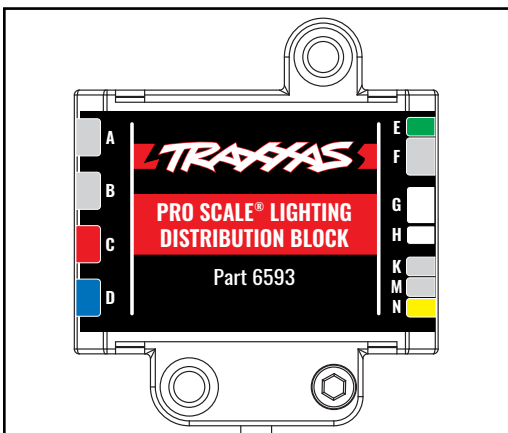

Wiring connectors for the lights are labeled with numbers and/or colors.

Letter	Colors	Description	Function
B	N/A	Rear turn signal harness	Rear turn signal LED
C	Red	Tail light harness	Tail light and brake light LEDs
E	Green	Rear independent turn signal jumper	Install when using rear independent turn signals
G	White	Head light assembly harness	Head lights, hood markers, and side marker light LEDs
H	White	Front turn signal harness	Front turn signal LEDs
M	N/A	Roof light bar high/low harness	LED light bar that mounts to roof of vehicle

Chassis Wiring Diagram

**Chassis Wiring
(Top Down View)
(G 63® shown)**

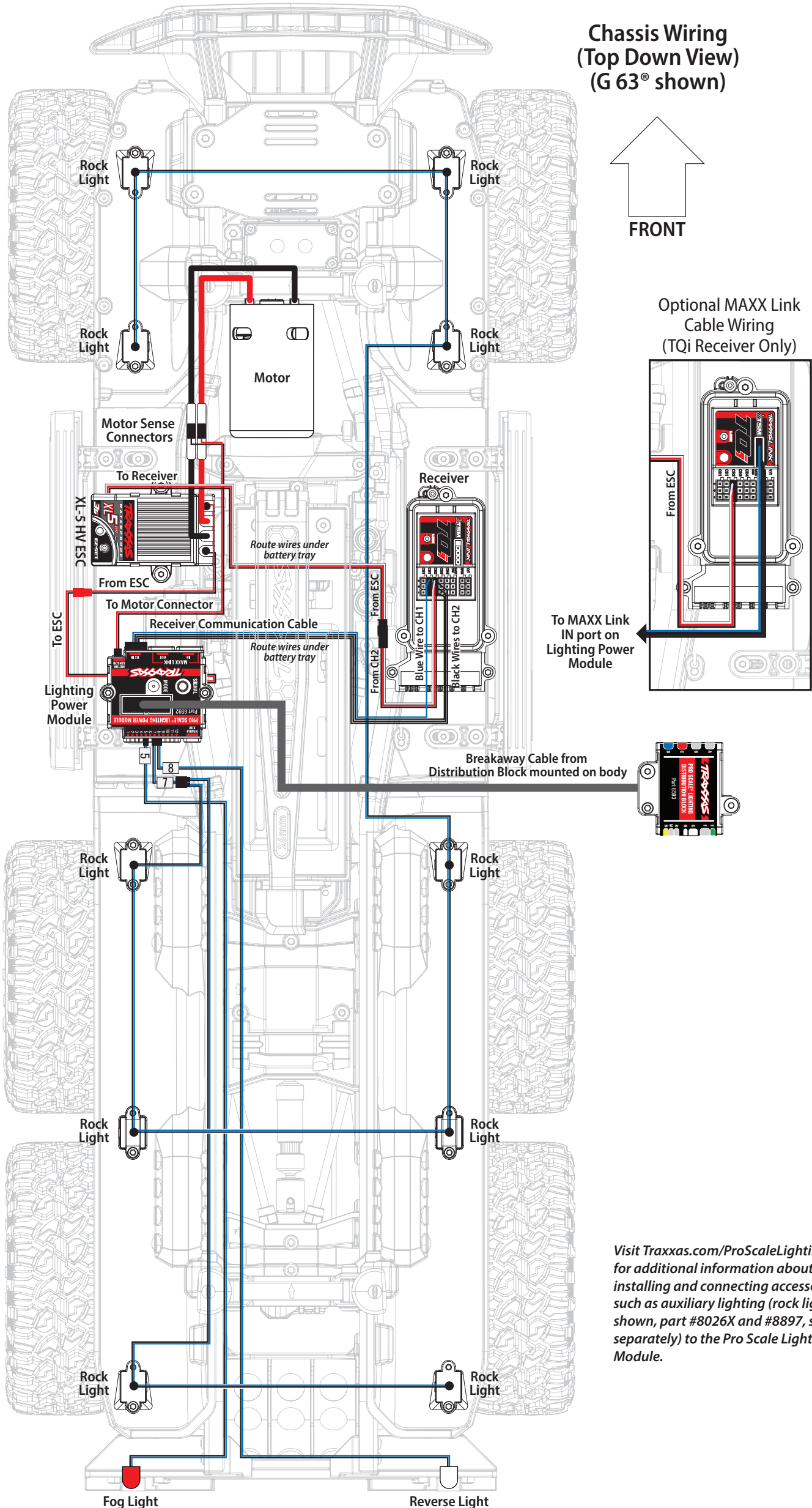
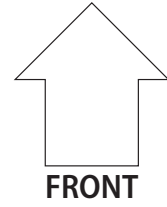

**Optional MAXX Link
Cable Wiring
(TQi Receiver Only)**

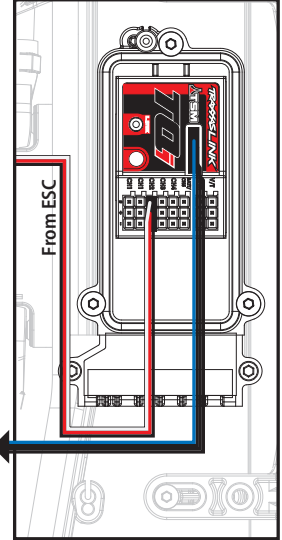

Visit Traxxas.com/ProScaleLighting for additional information about installing and connecting accessories such as auxiliary lighting (rock lights shown, part #8026X and #8897, sold separately) to the Pro Scale Lighting Module.

G 500[®] Body Wiring Diagram

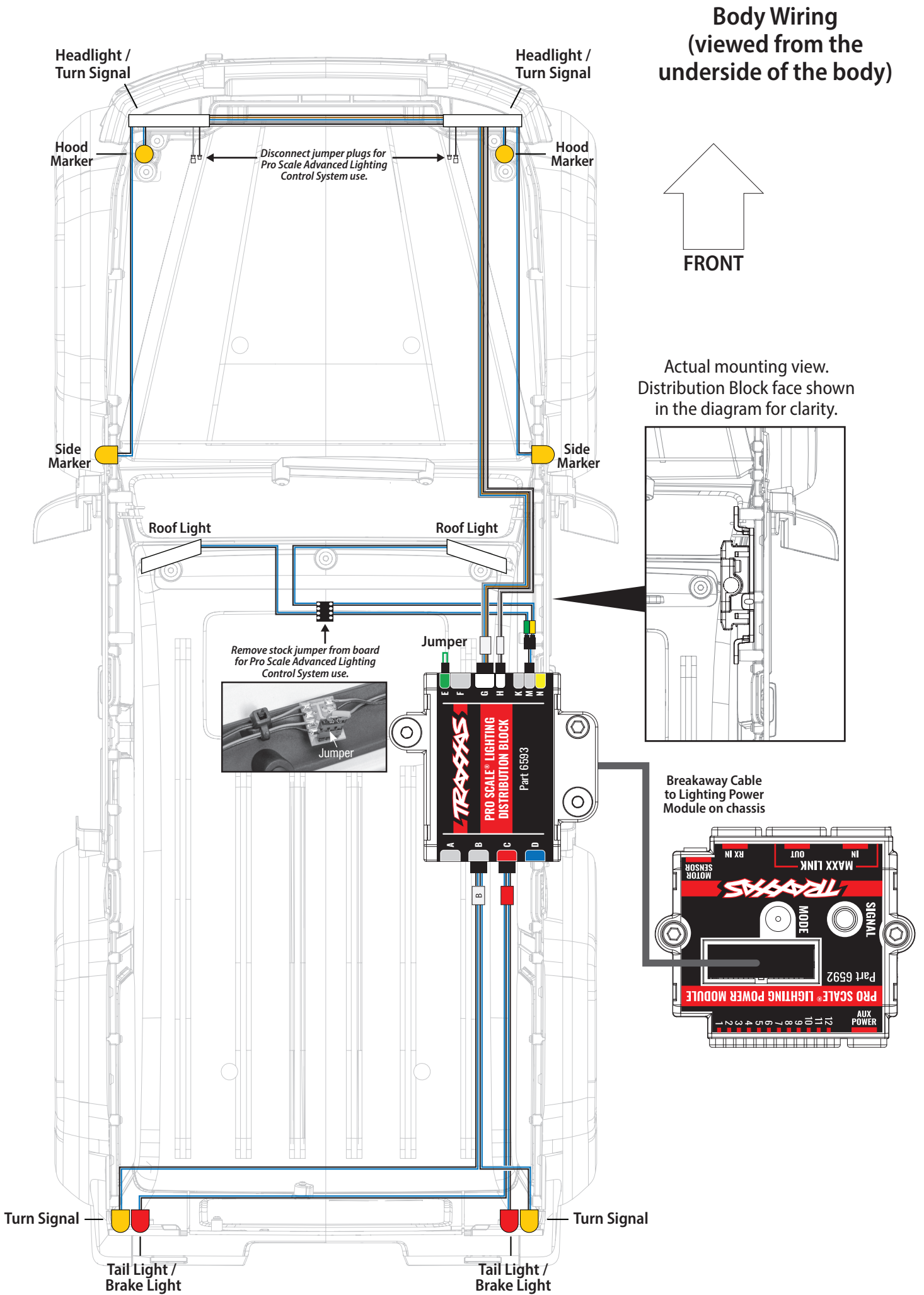

G 63[®] Body Wiring Diagram

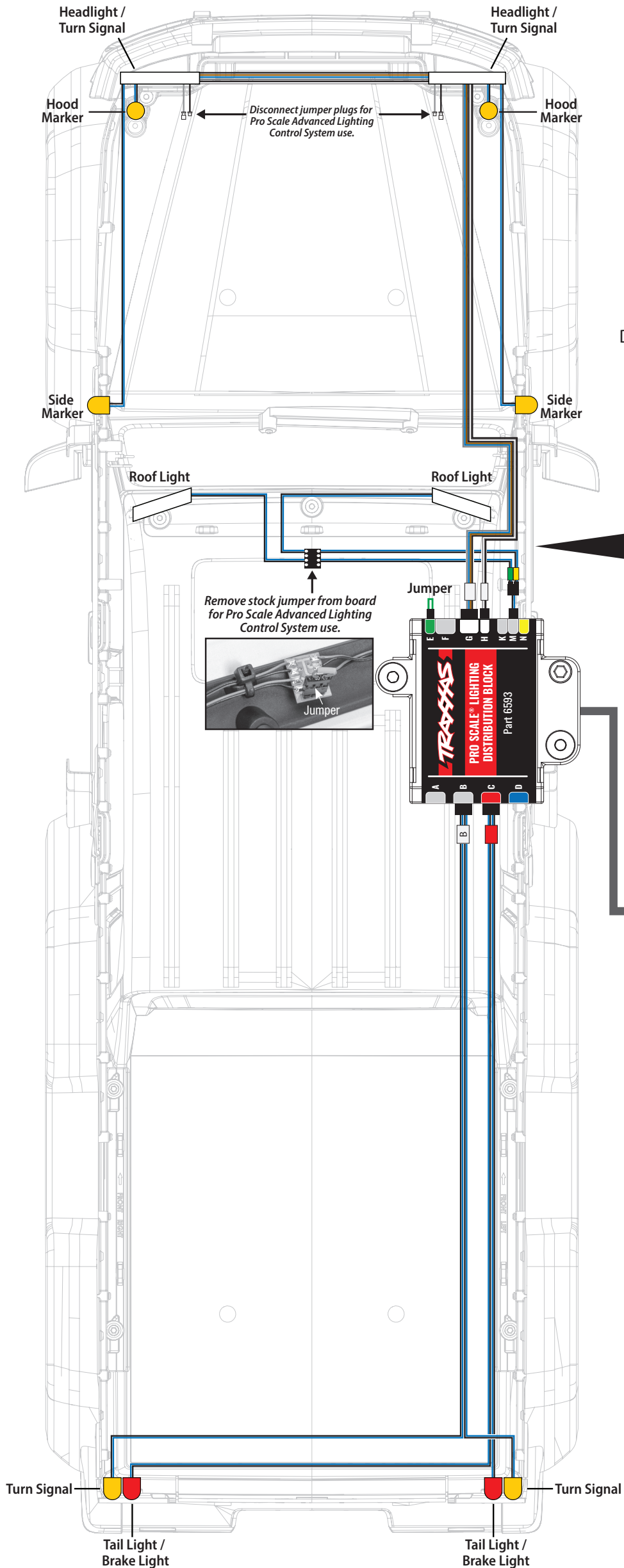

Body Wiring
(viewed from the underside of the body)

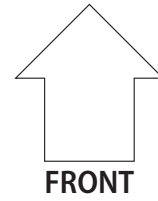

Actual mounting view.
Distribution Block face shown
in the diagram for clarity.

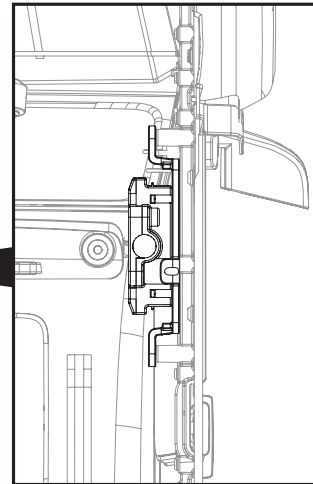

Breakaway Cable
to Lighting Power
Module on chassis

