

MODEL 68277-4

SLASH 4x4 ULTIMATE

TRAXXAS

OWNER'S MANUAL

TABLE OF CONTENTS

- 2 BEFORE YOU PROCEED
- 4 SAFETY PRECAUTIONS
- 7 ANATOMY OF THE SLASH 4x4 ULTIMATE
- 8 TOOLS, SUPPLIES, AND REQUIRED EQUIPMENT
- 9 QUICK START: GETTING UP TO SPEED
- 10 TRAXXAS TQi RADIO AND VELINEON BRUSHLESS POWER SYSTEM
- 18 ADJUSTING THE ELECTRONIC SPEED CONTROL
- 20 DRIVING YOUR MODEL
- 23 BASIC TUNING ADJUSTMENTS
- 25 MAINTAINING YOUR MODEL
- 27 ADVANCED TUNING ADJUSTMENTS
- 33 TQi ADVANCED TUNING GUIDE

This manual contains the instructions you will need to operate and maintain your model so that you can enjoy it for years to come. We want you to feel confident that you own one of the best-performing models in the market and that it is backed by a team of professionals who aim to provide the highest level of factory support possible. Traxxas models are about experiencing total performance and satisfaction, not just with your model, but also with the company that stands behind it.

We know you're excited about getting your new model on the road, but it's very important that you take some time to read through the Owner's Manual. This manual contains all the necessary set-up and operating procedures that will allow you to unlock the performance potential that

BEFORE YOU PROCEED

Carefully read and follow all instructions in this and any accompanying materials to prevent serious damage to your model. Failure to follow these instructions will be considered abuse and/or neglect.

Before running your model, look over this entire manual and examine the model carefully. If for some reason you decide it is not what you wanted, then do not continue any further. **Your hobby dealer absolutely cannot accept a model for return or exchange after it has been run.**

WARNINGS, HELPFUL HINTS, & CROSS-REFERENCES

Throughout this manual, you'll notice warnings and helpful hints identified by the icons below. Be sure to read them!



An important warning about personal safety or avoiding damage to your model and related components.



Special advice from Traxxas to make things easier and more fun.



Refers you to a page with a related topic.

REGISTERING YOUR MODEL

In order to serve you better as our customer, please register your product within 10 days of your purchase online at [Traxxas.com/register](https://www.traxxas.com/register).

[Traxxas.com/register](https://www.traxxas.com/register)

Traxxas engineers designed into your model. Also be sure to read and follow the precautions and warnings in this manual and on any labels or tags attached to your model. They are there to educate you on how to operate your model safely and also get maximum life and performance from your model.

Even if you are an experienced R/C enthusiast, it's important to read and follow the procedures in this manual.

Thank you again for going with Traxxas. We work hard every day to ensure you receive the highest level of customer satisfaction possible. We truly want you to enjoy your new model!

SUPPORT

If you have any questions about your model or its operation, call the Traxxas Technical Support Line toll-free at: **1-888-TRAXXAS (1-888-872-9927)***

Technical support is available 7 days a week from 8:30am to 9:00pm central time. Technical assistance is also available at [Traxxas.com/support](https://www.traxxas.com/support). You may also e-mail customer support with your question at support@traxxas.com. Join thousands of registered members in our online community at [Traxxas.com](https://www.traxxas.com).

Traxxas offers a full-service, on-site repair facility to handle any of your Traxxas service needs. Maintenance and replacement parts may be purchased directly from Traxxas by phone or online at [Traxxas.com](https://www.traxxas.com). You can save time, along with shipping and handling costs, by purchasing replacement parts from your local dealer.

Do not hesitate to contact us with any of your product support needs. We want you to be thoroughly satisfied with your new model!



Quick Start

This manual is designed with a Quick Start path that outlines the necessary procedures to get your model up and running in the shortest time possible. If you are an experienced R/C enthusiast you will find it helpful and fast. Be sure and read through the rest of the manual to learn about important safety, maintenance, and adjustment procedures. Turn to page 9 to begin.



*Toll-free support is available to U.S. residents only.

SLASH 4X4 ULTIMATE

The next-generation Slash 4X4 Ultimate represents Ready-To-Race® performance at the highest level. The Slash 4X4 Ultimate pushes the performance envelope; its new Low-CG chassis delivers superior handling and maximum corner speed and new 13mm bore GTR hard-anodized aluminum shocks provide consistent damping and smooth suspension action lap-after-lap. The result is lightning-fast steering response and smooth, consistent damping that raises the bar even higher on Slash 4X4 handling and precise control. The TQi Radio System with the Traxxas Link Wireless

Module and Slash 4X4 Ultimate's factory-installed telemetry enable real-time data capture and set the standard for tuning ease and versatility. To truly make this the Ultimate Slash 4X4, the specs are completed with nearly every factory option available. Simply put, it's the best of the best.



Aluminum C-hubs and Steering Blocks

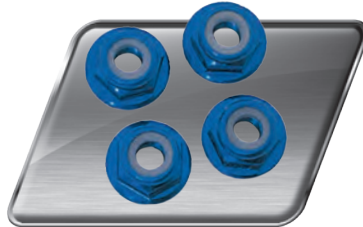

Aluminum Wheel nuts



Aluminum Rear Hub Carriers



Front and Rear Sway Bars



BFGoodrich® Tires with
S1 Racing Compound
(Style varies by model)



Blue-Anodized PTFE
Coated GTR Shocks

FCC Compliance

This device contains a module that complies with the limits for a Class B digital device as described in part 15 of the FCC rules. Operation is subject to the following two conditions: (1) This device may not cause harmful interference, and (2) this device must accept any interference received, including interference that may cause undesired operation.

The limits for a Class B digital device are designed to provide reasonable protection against harmful interference in residential settings. This product generates, uses and can radiate radio frequency energy, and, if not operated in accordance with the instructions, may cause harmful interference to radio communications. The user is cautioned that changes or modifications not expressly approved by the party responsible for compliance could void the user's authority to operate the equipment.

Canada, Industry Canada (IC)

This Class B digital apparatus complies with Canadian ICES-003 and RSS-210. This device complies with Industry Canada license exempt RSS standard(s). Operation is subject to the following two conditions: This device may not cause interference, and This device must accept any interference, including interference that may cause undesired operation of the device.

Radio Frequency (RF) Exposure Statement

This equipment complies with radio frequency exposure limits set forth by FCC and Industry Canada for an uncontrolled environment. This equipment should be installed and operated with a minimum distance of 20 centimeters between the radiator and your body or bystanders and must not be co-located or operating in conjunction with any other antenna or transmitter.

Operation Frequency: 2414–2453 MHz

Maximum Radio Frequency Power: Maximum Peak Power 9.7 dBm

Entire contents ©2023 Traxxas. All rights reserved. Traxxas, Ready-To-Race, Ready-To-Win, Slash, Velineon, and ProGraphix are trademarks or registered trademarks of Traxxas. Other brand names and marks are the property of their respective holders and are used only for purposes of identification. No part of this manual may be reproduced or distributed in print or electronic media without the express written permission of Traxxas. Specifications are subject to change without notice.

Traxxas
6250 Traxxas Way
McKinney, TX 75070
Phone: 972-549-3000
Toll-free 1-888-TRAXXAS

Internet:
Traxxas.com
E-mail:
support@Traxxas.com



All instructions and precautions outlined in this manual should be strictly followed to ensure safe operation of your model.



This model is not intended for use by children under 14 years of age without the supervision of a responsible and knowledgeable adult. Gearing and battery choice (see *LiPo Batteries, right*) affect the skill level of the model. See chart below.



Gearing: Stock Pinion
Battery: 7-Cell NiMH
Voltage*: 8.4V
mAh: 3000+mAh



Gearing: Opt. Pinion
Battery: 7-Cell NiMH
Voltage*: 8.4V
mAh: 3000+mAh



Gearing: Stock Pinion
Battery: 3S LiPo
Voltage*: 11.1V
mAh: 5000+mAh



Gearing: Opt. Gearing
Battery: 3S LiPo
Voltage*: 11.1V
mAh: 5000+mAh

*Nominal

See the gearing chart on page 27 for more information.



All of us at Traxxas want you to safely enjoy your new model. Operate your model sensibly and with care, and it will be exciting, safe, and fun for you and those around you. Failure to operate your model in a safe and responsible manner may result in property damage and serious injury. The precautions and instructions provided or available for this product(s) should be strictly followed to help ensure safe operation. You alone must see that the instructions are followed and the precautions are adhered to.

Important Points to Remember

- Your model is not intended for use on public roads or congested areas where its operation can conflict with or disrupt pedestrian or vehicular traffic.
- Never, under any circumstances, operate the model in crowds of people. Your model is very fast and could cause injury if allowed to collide with anyone.
- Because your model is controlled by radio, it is subject to radio interference from many sources that are beyond your control. Since radio interference can cause momentary losses of radio control, always allow a safety margin in all directions around the model in order to prevent collisions.
- The motor, battery, and speed control can become hot during use. Be careful to avoid getting burned.
- Don't operate your model at night, or anytime your line of sight to the model may be obstructed or impaired in any way.
- **Most importantly, use good common sense at all times.**

Speed Control

Your model's electronic speed control (ESC) is an extremely powerful electronic device capable of delivering high current. Please closely follow these precautions to prevent damage to the speed control or other components.

- **Disconnect the Battery:** Always disconnect the battery or batteries from the speed control when not in use.
- **Insulate the Wires:** Always insulate exposed wiring with heat shrink tubing to prevent short circuits.

- **Transmitter on First:** Switch on your transmitter first before switching on the speed control to prevent runaways and erratic performance.
- **Don't Get Burned:** The ESC and motor can become extremely hot during use, so be careful not to touch them until they cool. Supply adequate airflow for cooling.
- **Use the Factory-Installed Connectors:** Do not change the battery and motor connectors. Improper wiring can cause fire or damage to the ESC. Please note that modified speed controls can be subject to a rewiring fee when returned for service.
- **No Reverse Voltage:** The ESC is not protected against reverse polarity voltage.
- **No Schottky Diodes:** External Schottky diodes are not compatible with reversing speed controls. Using a Schottky diode with your Traxxas speed control will damage the ESC and void the 30-day warranty.
- **Always** adhere to the minimum and maximum limitations of the speed control as stated in the specifications table in the Owner's Manual. If your ESC operates on two batteries, do not mix battery types and capacities. Use the same voltage and capacity for both batteries. Using mismatched battery packs could damage the batteries and electronic speed control.

Recycling Your Traxxas iD® NiMH Battery

Traxxas strongly encourages you to recycle iD® NiMH batteries when they reach the end of their useful life. **Do not throw your battery in the trash.** All Traxxas iD® NiMH battery packs display the RBRC (Rechargeable Battery Recycling Corporation) icon, indicating they are recyclable. To find a recycling center near you, ask your local hobby dealer or visit www.call2recycle.org.



WARNING! CAUTION! DANGER!

FIRE HAZARD! Your model is able to use LiPo batteries. Charging and discharging batteries has the potential for fire, explosion, serious injury, and property damage if not performed per the instructions. Before use, read and follow all manufacturer's instructions, warnings, and precautions. In addition, Lithium Polymer (LiPo) batteries pose a SEVERE risk of fire if not properly handled per the instructions and require special care and handling procedures for long life and safe operation. LiPo batteries are intended only for advanced users that are educated on the risks associated with LiPo battery use. Traxxas does not recommend that anyone under the age of 18 use or handle LiPo battery packs without the supervision of a knowledgeable and responsible adult. Dispose of used batteries according to the instructions.

Important Warnings for users of Lithium Polymer (LiPo) batteries:

- Your model is able to use LiPo batteries. LiPo batteries have a minimum safe discharge voltage threshold that should not be exceeded. The electronic speed control is equipped with built-in Low-Voltage Detection that alerts the driver when LiPo batteries have reached their minimum voltage (discharge) threshold. It is the driver's responsibility to stop immediately to prevent the battery pack from being discharged below its safe minimum threshold.
- Low-Voltage Detection is just one part of a comprehensive plan for safe LiPo battery use. It is critical to follow all instructions for safe and proper charging, use, and storage of LiPo batteries. Make sure you understand how to use your LiPo batteries. If you have questions about LiPo battery usage, please consult with your local hobby dealer or contact the battery manufacturer. As a reminder, all batteries should be recycled at the end of their useful life.
- ONLY use a Traxxas iD charger to charge Traxxas iD batteries. ONLY use a Lithium Polymer (LiPo) balance charger with a balance adapter port to charge LiPo batteries. Never use NiMH or NiCad-type chargers or charge modes to charge LiPo batteries. DO NOT charge LiPo batteries with a NiMH-only charger. The use of a NiMH or NiCad charger or charge mode will damage LiPo batteries and may cause fire, personal injury, and/or property damage.



- NEVER charge LiPo battery packs in series or parallel. Charging packs in series or parallel may result in improper charger cell recognition and an improper charging rate that may lead to overcharging, cell imbalance, cell damage, and fire.
 - ALWAYS inspect your LiPo batteries carefully before charging. Look for any loose leads or connectors, damaged wire insulation, damaged cell packaging, impact damage, fluid leaks, swelling (a sign of internal damage), cell deformity, missing labels, or any other damage or irregularity. If any of these conditions are observed, do not charge or use the battery pack. Follow the disposal instructions included with your battery to properly and safely dispose of the battery.
 - DO NOT store or charge LiPo batteries with or around other batteries or battery packs of any type, including other LiPos.
 - Store and transport your battery pack(s) in a cool dry place. DO NOT store in direct sunlight. DO NOT allow the storage temperature to exceed 140°F or 60°C, such as in the trunk of a car, or the cells may be damaged and create a fire risk.
 - DO NOT disassemble LiPo batteries or cells.
 - DO NOT attempt to build your own LiPo battery pack from loose cells.
- Charging and handling precautions for all battery types:**
- BEFORE you charge, ALWAYS confirm that the charger settings exactly match the type (chemistry), specification, and configuration of the battery to be charged. DO NOT exceed the maximum manufacturer recommended charge rate.
 - DO NOT attempt to charge non-rechargeable batteries (explosion hazard), batteries that have an internal charge circuit or a protection circuit, batteries that have been altered from original manufacturer configuration, or batteries that have missing or unreadable labels, preventing you from properly identifying the battery type and specifications.
 - ALWAYS use a Traxxas iD charger to charge Traxxas iD batteries. DO NOT use a non-Traxxas charger to charge Traxxas iD batteries. It is not recommended, but if you choose to use a non-Traxxas charger or battery, read and follow all of the manufacturer's warnings and instructions.
 - DO NOT let any exposed battery contacts or wires touch each other. This will cause the battery to short circuit and create the risk of fire.

(continued on next page)

(continued from previous page)

- While charging or discharging, ALWAYS place the battery (all types of batteries) in a fire retardant/fire proof container and on a non-flammable surface such as concrete.
- DO NOT charge batteries inside of an automobile. DO NOT charge batteries while driving in an automobile.
- NEVER charge batteries on wood, cloth, carpet, or on any other flammable material.
- ALWAYS charge batteries in a well-ventilated area.
- REMOVE flammable items and combustible materials from the charging area.
- DO NOT leave the charger and battery unattended while charging, discharging, or anytime the charger is ON with a battery connected. If there are any signs of a malfunction or in the event of an emergency, unplug the charger from the power source and disconnect the battery from the charger.
- DO NOT operate the charger in a cluttered space, or place objects on top of the charger or battery.
- If any battery or battery cell is damaged in any way, DO NOT charge, discharge, or use the battery.
- Keep a Class D fire extinguisher nearby in case of fire.
- DO NOT disassemble, crush, short circuit, or expose the batteries to flame or other source of ignition. Toxic materials could be released. If eye or skin contact occurs, flush with water.
- (temperature greater than 110°F / 43°C), immediately disconnect the battery from the charger and discontinue charging.
- Allow the battery pack to cool off between runs (before charging).
- ALWAYS unplug the charger and disconnect the battery when not in use.
- ALWAYS unplug the battery from the electronic speed control when the model is not in use and when it is being stored or transported.
- DO NOT disassemble the charger.
- REMOVE the battery from your model or device before charging.
- DO NOT expose the charger to water or moisture. For indoor use only.
- DO NOT use an adapter of any kind or modify or change the battery plug/connector.
- ALWAYS store battery packs safely out of the reach of children or pets. Children should always have adult supervision when charging and handling batteries.
- Nickel-Metal Hydride (NiMH) batteries must be recycled or disposed of properly.
- Always proceed with caution and use good common sense at all times.

ANATOMY OF THE SLASH 4x4 ULTIMATE

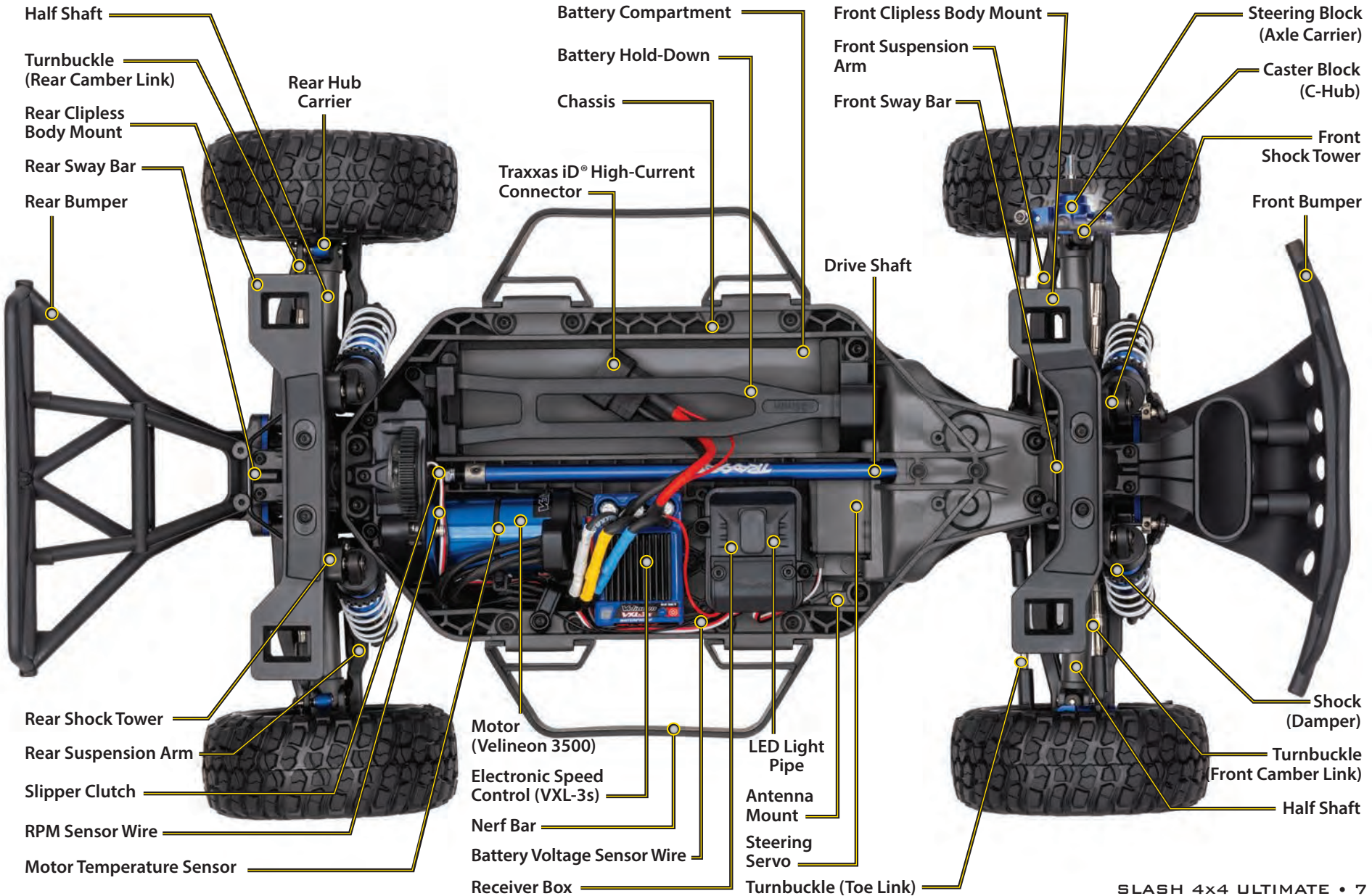

Half Shaft

Turnbuckle
(Rear Camber Link)

Rear Clipless
Body Mount

Rear Sway Bar

Rear Bumper

Rear Shock Tower

Rear Suspension Arm

Slipper Clutch

RPM Sensor Wire

Motor Temperature Sensor

Battery Compartment

Battery Hold-Down

Chassis

Traxxas iD® High-Current
Connector

Motor
(Velineon 3500)

Electronic Speed
Control (VXL-3s)

Nerf Bar

Battery Voltage Sensor Wire

Receiver Box

Front Clipless Body Mount

Front Suspension
Arm

Front Sway Bar

Drive Shaft

LED Light
Pipe

Antenna
Mount

Steering
Servo

Turnbuckle (Toe Link)

Steering Block
(Axle Carrier)

Caster Block
(C-Hub)

Front
Shock Tower

Front Bumper

Shock
(Damper)

Turnbuckle
Front Camber Link

Half Shaft

TOOLS, SUPPLIES, AND REQUIRED EQUIPMENT



For more information on batteries, see *Use the Right Batteries* on page 13.



Recommended Equipment

These items are not required for the operation of your model, but are a good idea to include in any R/C toolbox:

- Safety glasses
- Traxxas Ultra Premium Tire Glue, Part #6468 (CA glue)
- Hobby knife
- Side cutters and/or needle nose pliers
- Philips screwdriver
- Soldering iron

Your model comes with a set of specialty metric tools. You'll need to purchase other items, available from your hobby dealer, to operate and maintain your model.

Supplied Tools and Equipment



2.5mm "L" wrench



2.0mm "L" wrench



1.5mm "L" wrench



Shock wrench



8mm/4mm wrench



4-way wrench

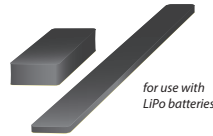

Foam battery spacer

*for use with
LiPo batteries*



Suspension multi-tool



Optional
pinion gear

Required Equipment



6 or 7-cell NiMH battery pack,
or 2S or 3S LiPo battery pack,
with Traxxas High-Current connector



*EZ-Peak™ Dual
(part #2972)*

Battery charger



4 AA alkaline batteries

**Battery and charger style are subject to change and may vary from images.*

 The following guide is an overview of the procedures for getting your model running. Look for the Quick Start logo on the bottom corners of Quick Start pages.

1. Read the safety precautions on pages 4-6

For your own safety, understand where carelessness and misuse could lead to personal injury and product damage.

6. Check servo operation • See page 16

Make sure the steering servo is working correctly.

2. Charge the battery pack • See pages 13

Your model requires a battery pack and a compatible battery charger (not included). NEVER use a NiMH or NiCad charger to charge LiPo batteries.

7. Range test the radio system • See page 16

Follow this procedure to make sure your radio system works properly at a distance and that there is no interference from outside sources.

3. Install batteries in the transmitter • See page 13

The transmitter requires 4 AA alkaline batteries (sold separately).

8. Detail your model • See sidebar, page 10

Apply other decals if desired.

4. Install the battery pack in the model • See page 14

Your model requires a fully charged battery pack (not included).

9. Drive your model • See page 20

Driving tips and adjustments for your model.

5. Turn on the radio system • See page 15

Make a habit of turning the transmitter on first and off last.

10. Maintaining your model • See page 25

Follow these critical steps to maintain the performance of your model and keep it in excellent running condition.



The Quick Start Guide is not intended to replace the full operating instructions available in this manual. Please read this entire manual for complete instructions on the proper use and maintenance of your model.

Look for the Quick Start logo at the bottom of Quick Start pages.





Applying the Decals

The main decals for your model have been applied at the factory. Additional decals are printed on self-adhesive clear mylar and are die-cut for easy removal. Use a hobby knife to lift the corner of a decal and lift it from the backing.

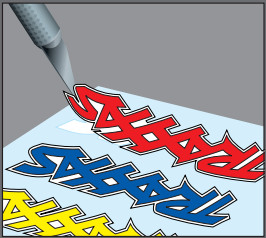

To apply the decals, place one end down, hold the other end up, and gradually smooth the decal down with your finger as you go. This will prevent air bubbles. Placing both ends of the decal down and then trying to smooth it out will result in air pockets. Look at the photos on the box for typical decal placement.

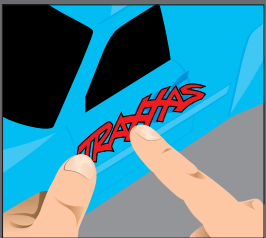

INTRODUCTION

Your model includes the latest Traxxas TQi 2.4GHz transmitter with Traxxas Link™ Model Memory. The transmitter's easy-to-use design provides instant driving fun for new R/C enthusiasts, and also offers a full compliment of pro-level tuning features for advanced users – or anyone interested in experimenting with the performance of their model. The steering and throttle channels feature adjustable Exponential, End Points, and Sub-Trims. Steering and braking Dual Rate are also available. Many of the next-level features are controlled by the Multi-Function knob, which can be programmed to control a variety of functions. The detailed instructions (page 33) and Menu Tree (page 37) included in this manual will help you understand and operate the advanced functions of the new TQi radio system. For additional information and how-to videos, visit Traxxas.com.

RADIO AND POWER SYSTEM TERMINOLOGY

Please take a moment to familiarize yourself with these radio and power system terms. They will be used throughout this manual. A detailed explanation of the advanced terminology and features of your new radio system begins on page 33.

2.4GHz Spread Spectrum – This model is equipped with the latest R/C technology. Unlike AM and FM systems that require frequency crystals and are prone to frequency conflicts, the TQi system automatically selects and locks onto an open frequency and offers superior resistance to interference and “glitching.”

BEC (Battery Eliminator Circuit) - The BEC can either be in the receiver or in the ESC. This circuit allows the receiver and servos to be powered by the main battery pack in an electric model. This eliminates the need to carry a separate pack of 4 AA batteries to power the radio equipment.

Brushless Motor - A D/C brushless motor replaces the brushed motor's traditional commutator and brush arrangement with intelligent electronics that energize the electromagnetic windings in sequence to provide rotation. Opposite of a brushed motor, the brushless motor has its windings (coils) on the perimeter of the motor can and the magnets are mounted to the spinning rotor shaft.

Cogging - Cogging is a condition sometimes associated with brushless motors. Typically it is a slight stutter noticed when accelerating from a stop. It happens for a very short period as the signals from the electronic speed control and the motor synch

with each other. The VXL-3s electronic speed control is optimized to virtually eliminate cogging.

Current - Current is a measure of power flow through the electronics, usually measured in amps. If you think of a wire as a garden hose, current is a measure of how much water is flowing through the hose.

ESC (Electronic Speed Control) - An electronic speed control is the electronic motor control inside the model. The VXL-3s electronic speed control uses advanced circuitry to provide precise, digital proportional throttle control. Electronic speed controls use power more efficiently than mechanical speed controls so that the batteries run longer. An electronic speed control also has circuitry that prevents loss of steering and throttle control as the batteries lose their charge.

Frequency band - The radio frequency used by the transmitter to send signals to your model. This model operates on the 2.4GHz direct-sequence spread spectrum.

kV Rating - Brushless motors are often rated by their kV number. The kV rating equals no-load motor rpm with 1 volt applied. The kV increases as the number of wire turns in the motor decreases. As the kV increases, the current draw through the electronics also increases. The Velineon 3500 motor is a 3500 kV motor optimized for the best speed and efficiency in lightweight 1/10 scale models.

LiPo - Abbreviation for Lithium Polymer. Rechargeable LiPo battery packs are known for their special chemistry that allows extremely high energy density and current handling in a compact size. These are high-performance batteries that require special care and handling. For advanced users only.

mAh - Abbreviation for milliamp hour. A measure of the capacity of the battery pack. The higher the number, the longer the battery will last between recharges.

Neutral position - The standing position that the servos seek when the transmitter controls are at the neutral setting.

NiCad - Abbreviation for nickel-cadmium. The original rechargeable hobby pack, NiCad batteries have very high current handling, high capacity, and can last up to 1000 charging cycles. Good charging procedures are required to reduce the possibility of developing a “memory” effect and shortened run times.

NiMH - Abbreviation for nickel-metal hydride. Rechargeable NiMH batteries offer high current handling and much greater resistance to the “memory” effect. NiMH batteries generally allow higher capacity than NiCad batteries. They can last up to 500 charge cycles. A peak charger designed for NiMH batteries is required for optimal performance.

Receiver - The radio unit inside your model that receives signals from the transmitter and relays them to the servos.

Resistance - In an electrical sense, resistance is a measure of how an object resists or obstructs the flow of current through it. When flow is constricted, energy is converted to heat and is lost. The Velineon power system is optimized to reduce electrical resistance and the resulting power-robbing heat.

Rotor - The rotor is the main shaft of the brushless motor. In a brushless motor, the magnets are mounted to the rotor, and the electromagnetic windings are built into the motor housing.

Sensored - Sensored refers to a type of brushless motor that uses an internal sensor in the motor to communicate rotor position information back to the electronic speed control. The VXL-3s electronic speed control is able to use sensored motors when applications benefit from them (such as some sanctioned racing classes).

Sensorless - Sensorless refers to a brushless motor that uses advanced instructions from an electronic speed control to provide smooth operation. Additional motor sensors and wiring are not required. The VXL-3s electronic speed control is optimized for smooth sensorless control.

Servo - Small motor unit in your model that operates the steering mechanism.

Solder Tabs - Accessible, external contacts on the motor that allows for easy wire replacement. The Velineon 3500 is equipped with solder tabs.

Transmitter - The hand-held radio unit that sends throttle and steering instructions to your model.

Trim - The fine-tuning adjustment of the neutral position of the servos made by adjusting the throttle and steering trim knobs on the face of the transmitter. **Note:** The Multi-Function knob must be programmed to serve as a throttle trim adjustment.

Thermal Shutdown Protection - Temperature sensing electronics used in the VXL-3s electronic speed control detect overloading and overheating of the transistor circuitry. If excessive temperature is detected, the unit automatically shuts down to prevent damage to the electronics.

2-channel radio system - The TQi radio system, consisting of the receiver, the transmitter, and the servos. The system uses two channels: one to operate the throttle and one to operate the steering.

Voltage - Voltage is a measure of the electrical potential difference between two points, such as between the positive battery terminal and ground. Using the analogy of the garden hose, while current is the quantity of water flow in the hose, voltage corresponds to the pressure that is forcing the water through the hose.

IMPORTANT RADIO SYSTEM PRECAUTIONS

- Do not kink the receiver’s antenna wire. Kinks in the antenna wire will reduce range.
- DO NOT CUT any part of the receiver’s antenna wire. Cutting the antenna will reduce range.
- Extend the antenna wire in the model as far as possible for maximum range. It is not necessary to extend the antenna wire out of the body, but wrapping or coiling the antenna wire should be avoided.
- Do not allow the antenna wire to extend outside the body without the protection of an antenna tube, or the antenna wire may get cut or damaged, reducing range. It is recommended to keep the wire inside the body (in the antenna tube) to prevent the chance of damage.



To prevent loss of radio range do not kink or cut the black wire, do not bend or cut the metal tip, and do not bend or cut the white wire at the end of the metal tip.

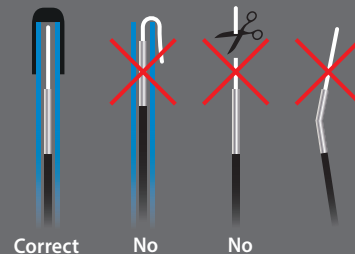

ESC/Motor Wiring Diagram

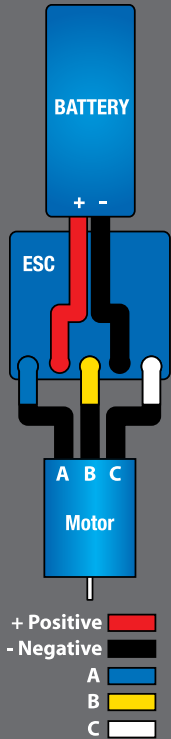

Your model is equipped with the newest TQi 2.4GHz transmitter with Traxxas Link™ Model Memory. The transmitter has two channels for controlling your throttle and steering. The receiver inside the model has 5 output channels. Your model is equipped with one servo and an electronic speed control.

TRANSMITTER AND RECEIVER

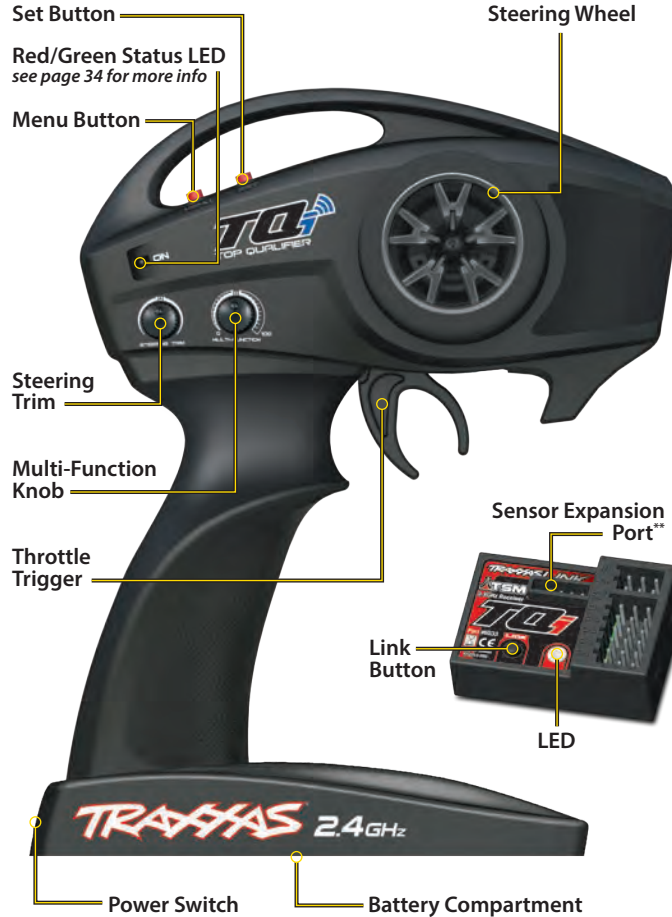

MODEL WIRING DIAGRAM

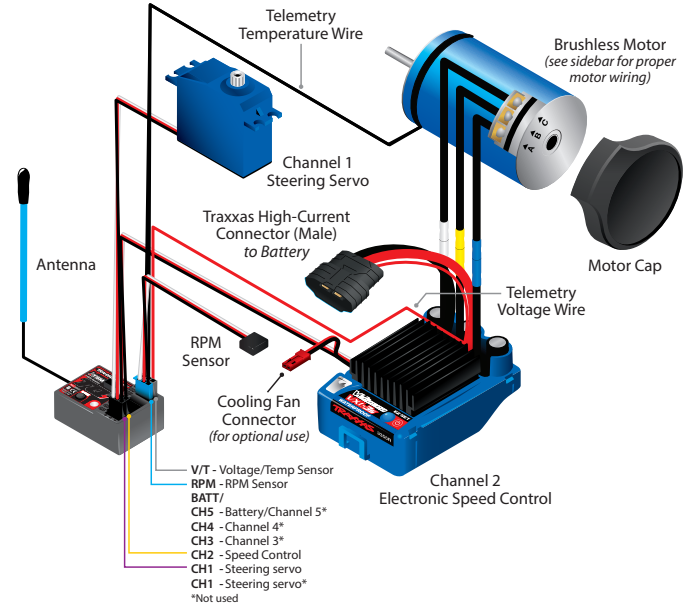

VXL-3s ELECTRONIC SPEED CONTROL

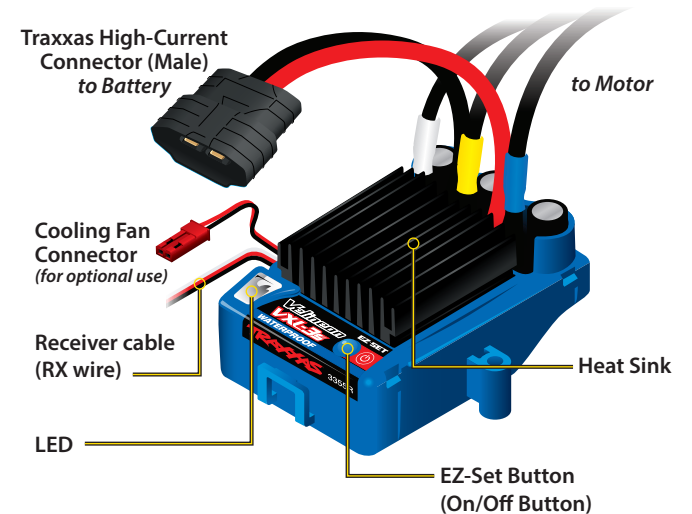

** Accessory sensor expansion port for use with the Telemetry Expander Module (see Traxxas.com and included materials for more information)

INSTALLING TRANSMITTER BATTERIES

Your TQi transmitter uses 4 AA batteries. The battery compartment is located in the base of the transmitter.



1. Remove the battery compartment door by pressing the tab and sliding the door open.
2. Install the batteries in the correct orientation as indicated in the battery compartment.
3. Reinstall the battery door and snap it closed.
4. Turn on the transmitter and check the status indicator for a solid green light.

If the status LED flashes red, the transmitter batteries may be weak, discharged or possibly installed incorrectly. Replace with new batteries. The power indicator light does not indicate the charge level of the battery pack installed in the model. Refer to the Troubleshooting section on page 34 for more information on the transmitter Status LED codes.



SELECTING BATTERIES FOR YOUR MODEL

Your model does not include a battery or charger. One NiMH or LiPo battery equipped with a Traxxas High-Current Connector is required. **Traxxas Power Cell iD batteries are strongly recommended for maximum performance and safer charging.** The following chart lists all the available Power Cell iD batteries for your model:

LiPo Batteries with iD

2872X	5000mAh 11.1V 3-Cell 25C LiPo Battery
2857X	6400mAh 11.1V 3-Cell 25C LiPo Battery
2869X	7600mAh 7.4V 2-Cell 25C LiPo Battery
2854X	10000mAh 7.4V 2-Cell 25C LiPo Battery

NiMH Batteries with iD

2923X	Battery, Power Cell, 3000mAh (NiMH, 7-C flat, 8.4V)
2940X	Battery, Series 3 Power Cell, 3300mAh (NiMH, 7-C flat, 8.4V)
2942X	Battery, Series 3 Power Cell, 3300mAh (NiMH, 6-C flat, 7.2V)
2950X	Battery, Series 4 Power Cell, 4200mAh (NiMH, 7-C flat, 8.4V)
2952X	Battery, Series 4 Power Cell, 4200mAh (NiMH, 6-C flat, 7.2V)
2960X	Battery, Series 5 Power Cell, 5000mAh (NiMH, 7-C flat, 8.4V)

WARNING: FIRE HAZARD!
 Users of Lithium Polymer (LiPo) batteries must read the Warnings and Precautions beginning on page 4. You **MUST** use a LiPo balance charger for LiPo batteries or battery damage with the potential for fire will result.

SELECTING A CHARGER FOR YOUR MODEL

Make certain you choose the correct type of charger for the batteries you select. **Traxxas recommends you choose a genuine Traxxas EZ-Peak iD charger for safer charging and maximum battery life and performance.**

Charger	Part No.	NiMH Compatible	LiPo Compatible	Battery iD	Max. Cells
EZ-Peak Plus, 4 amps	2970	YES	YES	YES	3s
EZ-Peak Live, 12 amps	2971	YES	YES	YES	4s
EZ-Peak Dual, 8 amps	2972	YES	YES	YES	3s
EZ-Peak Live Dual, 26 amps	2973	YES	YES	YES	4s
EZ-Peak Plus 4s, 8 amps	2981	YES	YES	YES	4s

i If the status LED doesn't light green, check the polarity of the batteries. If you see any other flashing signal from the LED, refer to the chart on page 34 to identify the code.

i **Use the Right Batteries**
 Your transmitter uses AA batteries. Use new alkaline batteries. Do not use rechargeable AA cells to power the TQi transmitter, as they will not provide sufficient voltage for optimum transmitter performance.

Caution: Discontinue running your model at the first sign of weak batteries (flashing red light) to avoid losing control.



**Battery iD**

Traxxas recommended battery packs are equipped with Traxxas Battery iD. This exclusive feature allows Traxxas battery chargers (sold separately) to automatically recognize connected battery packs and optimize the charge settings for the battery. This eliminates the need to worry over charger settings and menus for the easiest and safest charging solution possible. Visit Traxxas.com to learn more about this feature and available Traxxas iD chargers and batteries.

**Battery Compartment Specs:**

- 166mm (6.54") long
x 49.5mm (1.95") wide
- Height with stock strap:
23mm (.91") or 25mm (.94")
- Height with Part #7426X
options battery standoffs:
Up to 44mm (1.73")

Note: There is some flex with the battery strap. It is possible to fit slightly taller batteries in the compartment.

INSTALLING THE BODY

Your Slash 4X4 Ultimate includes an innovative latching system for securing the body to the chassis (body clips are not required).

To remove the body for chassis access:

1. Reach beneath the truck body and pull the latches toward the outside of the truck body to release them from the front and rear body mounts.
2. Push up on the latches to fully disengage them from the mounts.
3. Lift the body straight up from the chassis. Lift the front and rear of the body evenly or it may become difficult to remove.

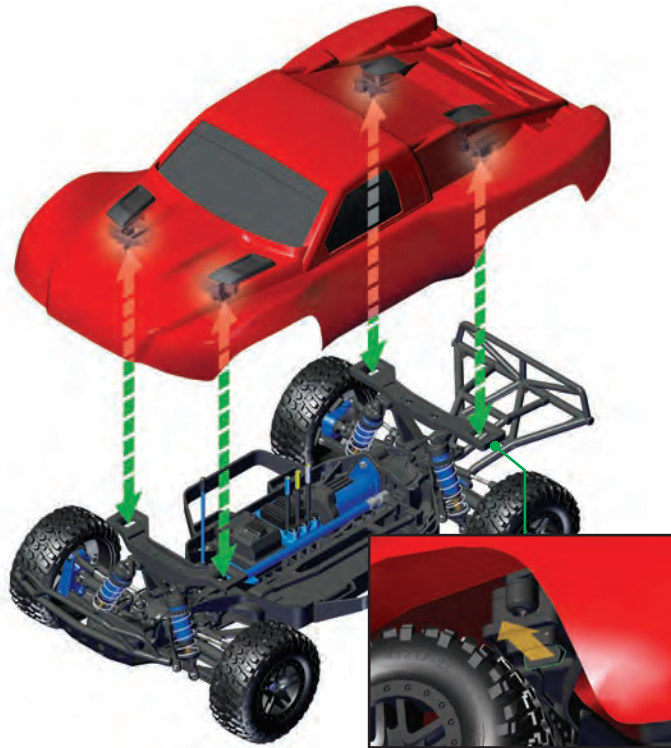
**To reinstall the body:**

1. Position the body on the chassis. Align the front and rear of the body with the bumpers.
2. Press down on the body at each latch location until the latches snap into place.

Note: To keep the clipless system functioning properly, periodically inspect and clean the latches in the body and the slots on the front and rear body mounts. If dirt and grime accumulate on these components, the clipless system will not operate smoothly.

INSTALLING THE BATTERY PACK

Install the battery pack with the battery wires facing the rear of the model. Insert the tabs of the battery hold-down into the slots in the rear hold-down retainer (A). Swing the battery hold-down towards the chassis and snap (lock) the end into the front hold-down retainer (B).

The Traxxas High-Current Connector

Your model is equipped with the Traxxas High-Current Connector. Standard connectors restrict current flow and are not capable of delivering the power needed to maximize the output of the VXL-3s. The Traxxas connector's gold-plated terminals, with large contact surfaces, ensure positive current flow with the least amount of resistance. Secure, long-lasting, and easy to grip, the Traxxas connector is engineered to extract all the power your battery has to give.



RADIO SYSTEM CONTROLS



RADIO SYSTEM RULES

- Always turn your TQi transmitter on first and off last. This procedure will help to prevent your model from receiving stray signals from another transmitter, or other source, and running out of control. Your model has electronic fail-safes to prevent this type of malfunction, but the first, best defense against a runaway model is to always turn the transmitter on first and off last.
- Always use new batteries for the radio system. Weak batteries will limit the radio signal between the receiver and the transmitter. Loss of the radio signal can cause you to lose control of your model.

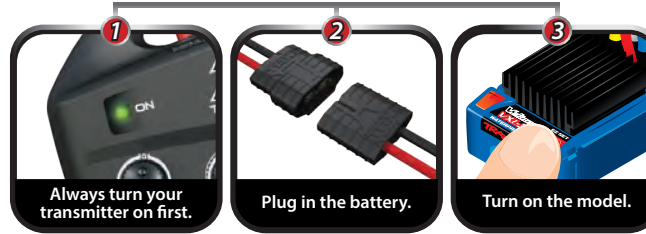

- Always turn your transmitter on first.
 - Plug in the battery.
 - Turn on the model.
- In order for the transmitter and receiver to bind to one another, the receiver in the model must be turned on within 20 seconds of turning on the transmitter. The transmitter LED will flash fast red, indicating a failure to link. If you miss it, simply turn off the transmitter and start over.
 - Always turn on the transmitter before plugging in the battery.

RADIO SYSTEM BASIC ADJUSTMENTS

Steering Trim

The electronic steering trim located on the face of the transmitter adjusts the neutral (center) point of the steering channel.



Note: Traxxas Stability Management (TSM) must be completely turned off while adjusting steering trim. See page 17 for TSM adjustments.

Multi-Function Knob

The Multi-Function knob can be programmed to control a variety of functions. From the factory, the Multi-Function knob controls Traxxas Stability Management (TSM). For more detail on TSM, refer to page 17.



! Remember, always turn the TQi transmitter on first and off last to avoid damage to your model.

i **Automatic Fail-Safe**
The TQi transmitter and receiver are equipped with an automatic fail-safe system that does not require user programming. In the event of signal loss or interference, the throttle will return to neutral and the steering will hold its last commanded position. If Fail-Safe activates while you are operating your model, determine the reason for signal loss and resolve the problem before operating your model again.

! Stop immediately at the first sign of weak batteries. Never turn the transmitter off when the battery pack is plugged in. The model could run out of control.



Using Reverse: While driving, push the throttle trigger forward to apply brakes. Once stopped, return the throttle trigger to neutral. Push the throttle trigger forward again to engage proportional reverse.

USING THE RADIO SYSTEM

The TQi Radio System has been pre-adjusted at the factory. The adjustment should be checked before running the model, in case of movement during shipping. Here's how:

1. Turn the transmitter switch on. The status LED on the transmitter should be solid green (not flashing).
2. **Elevate the model on a block or a stand so that all the tires are off the ground.** Make sure your hands are clear of the moving parts of the model.
3. Plug the battery pack in the model into the speed control.
4. The on/off switch is integrated into the speed control. With the transmitter on, press and release the EZ-Set button (.25 seconds). The LED will shine RED (see note, below). This turns the model on. To turn the VXL-3s off, press and hold the EZ-Set button until the LED turns off (.5 seconds). **Note:** If the LED shines green, Low-Voltage Detection is activated. This will cause erratic performance from a NiMH battery pack. The default factory setting is for Low-Voltage Detection to be disabled (LED shines red). Make sure to turn the low voltage detection on when using LiPo batteries. **Never use LiPo batteries while Low-Voltage Detection is turned off.** See page 18 for more information.
5. Turn the steering wheel on the transmitter back and forth and check for rapid operation of the steering servo. Also, check that the steering mechanism is not loose or binding. If the steering operates slowly, check for weak batteries.
6. When looking down at the model, the front wheels should be pointing straight ahead. If the wheels are turned slightly to the left or right, turn off TSM (see page 17) and slowly adjust the steering trim control on the transmitter until they are pointing straight ahead; then, return the multi-function knob to the desired TSM setting.
7. Gently operate the throttle trigger to ensure that you have forward and reverse operation, and that the motor stops when the throttle trigger is at neutral. **WARNING: Do not apply full throttle in forward or reverse while the model is elevated.**
8. Once adjustments are made, turn off the receiver on your model, followed by the hand-held transmitter.



Range-Testing the Radio System

Before each running session with your model, you should range-test your radio system to ensure that it operates properly.

1. Turn on the radio system and check its operation as described in the previous section.
2. Have a friend hold the model. Make sure hands and clothing are clear of the wheels and other moving parts on the model.
3. Walk away from the model with the transmitter until you reach the farthest distance you plan to operate the model.
4. Operate the controls on the transmitter once again to be sure that the model responds correctly.
5. Do not attempt to operate the model if there is any problem with the radio system or any external interference with your radio signal at your location.

Higher Speeds Require Greater Distance

The faster you drive your Slash 4X4 Ultimate, the more quickly it will near the limit of radio range. At 60mph, a model can cover 88 feet every second! It's a thrill, but use caution to keep your model in range. If you want to see your Slash 4X4 Ultimate achieve its maximum speed, it is best to position yourself in the middle of the truck's running area, not the far end, so you drive the truck towards and past your position. In addition to maximizing the radio's range, this technique will keep your model closer to you, making it easier to see and control.

No matter how fast or far you drive your Slash 4X4 Ultimate, always leave adequate space between you, the model, and others. Never drive directly toward yourself or others.

TQi Binding Instructions

For proper operation, the transmitter and receiver must be electronically "bound." **This has been done for you at the factory.** Should you ever need to re-bind the system or bind to an additional transmitter or receiver, follow these instructions. **Note:** The receiver must be connected to a 4.8-6.0v (nominal) power source for binding and the transmitter and receiver must be within 5 feet of each other.

1. Press and hold the transmitter's SET button as you switch the transmitter on. The transmitter's LED will flash red slowly.
2. Press and hold the receiver's LINK button as you switch on the speed control by pressing the EZ-Set button.
3. When the transmitter and receiver's LEDs turn solid green, the system is bound and ready for use. Confirm that the steering and throttle operate properly before driving your model.

TRAXXAS STABILITY MANAGEMENT (TSM)



Traxxas Stability Management or TSM allows you to experience all the speed and acceleration that was engineered into your Traxxas model by helping you to maintain

control of the vehicle in low-traction situations. TSM helps provide straight ahead full-throttle acceleration on slippery surfaces, without fishtailing, spinouts, or loss of control. TSM also dramatically improves braking control. High speed cornering and control is also made possible as TSM makes corrections for you, without intruding on your fun, or creating unexpected side effects.

The Multi-Function knob on the TQi transmitter has been programmed to control TSM. The recommended (default) setting for TSM is to rotate the knob to the 12:00 position (the zero mark on the dial).



Turn the knob clockwise to increase assistance; turn the knob counterclockwise to decrease assistance. Turn the knob counterclockwise to its stop to turn TSM completely off.



Note: TSM is deactivated automatically when driving or braking in reverse.

When driving on surfaces with some traction, decrease the TSM setting to allow the vehicle to feel more “loose” for power sliding, drifting, and so on. On surfaces with very little traction (loose dirt, smooth concrete, ice/snow), increase TSM to maximize acceleration and control.

Drive with TSM on and off to test how it is making your control of the vehicle easier and more precise. For more information, visit Traxxas.com/tsm.

Note: TSM must be completely turned off while adjusting steering trim.

SETTING UP THE ANTENNA

The receiver antenna has been set up and installed from the factory. The antenna is secured by a 3x4mm set screw. To remove the antenna tube, simply remove the set screw with the included 1.5mm wrench.

When reinstalling the antenna, first slide the antenna wire into the bottom of the antenna tube until the white tip of the antenna is at the top of the tube under the black cap. Next insert the antenna tube into the mount while making sure that antenna wire is in slot in the antenna mount, then install the set screw next to the antenna tube. Use the supplied 1.5mm wrench to tighten the screw just until the antenna tube is securely in place. Do not over tighten. **Do not bend or kink the antenna wire! See the side bar for more information. Do not shorten the antenna tube.**

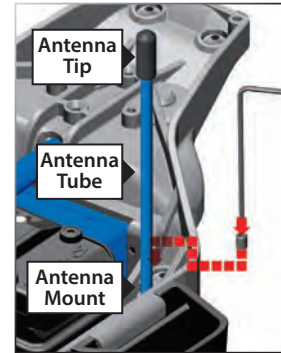

To prevent loss of radio range do not kink or cut the black wire, do not bend or cut the metal tip, and do not bend or cut the white wire at the end of the metal tip.

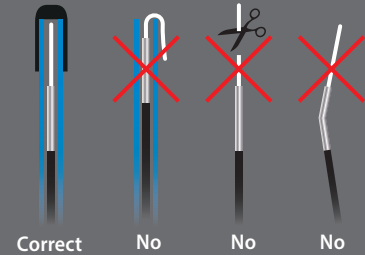

VXL-3s Specifications

Input voltage:
4.8-11.1V (4 to 9 cells
NiMH or 2S to 3S LiPo)

Supported Motors:
Brushless

Motor limit:
None

Continuous current:
200A

Peak current:
320A

BEC voltage:
6.0V DC

Transistor type:
MOSFET

Battery connector:
Traxxas High-Current
Connector

Motor connectors:
TRX 3.5mm bullet
connectors

Motor/Battery Wiring:
12-gauge Maxx® Cable

Thermal Protection:
2-stage thermal shutdown

VXL-3s Battery Settings (Low-Voltage Detection Setting)

The Velineon VXL-3s electronic speed control is equipped with built-in Low-Voltage Detection. The Low-Voltage Detection circuitry constantly monitors the battery voltage. When the battery voltage begins to reach the minimum recommended discharge voltage threshold for LiPo battery packs, the VXL-3s will limit the power output to 50% throttle. When the battery voltage attempts to fall below the minimum threshold, the VXL-3s will shut down all motor output. The LED on the speed control will slowly blink red, indicating a low-voltage shutdown. The VXL-3s will stay in this mode until a fully charged battery is connected.

When you turn your model on, the VXL-3s speed control's status LED will glow green, indicating that **Low-Voltage Detection is activated** to prevent over-discharging of LiPo batteries. **LiPo batteries are intended only for the most advanced users that are educated on the risks associated with LiPo battery use.**



WARNING: FIRE HAZARD!

Do not use LiPo batteries in this vehicle with Low-Voltage Detection disabled.

To verify the Low-Voltage Detection setting:

1. Turn on the transmitter (with the throttle at neutral).
2. Connect a fully charged battery pack to the VXL-3s.
3. Press and release the EZ-Set button to turn the VXL-3s on. If the LED is solid red, then the Low-Voltage Detection is **DISABLED** (not safe to use LiPo batteries). If the LED is solid green, then Low-Voltage Detection is **ACTIVATED**.

To activate Low-Voltage Detection (LiPo setting):

1. Make sure the LED on the VXL-3s is on and red.
2. Press and hold the EZ-Set button for ten seconds. The LED will turn off and then light green. Also, a "rising" musical tone will be emitted from the motor.
3. Low-Voltage Detection is now **ACTIVATED**.



To disable Low-Voltage Detection (NiMH setting):

1. Make sure the LED on the VXL-3s is on and green.
2. Press and hold the EZ-Set button for ten seconds. The LED will turn off and then light red. Also, a "falling" musical tone will be emitted from the motor.
3. Low-Voltage Detection is now **DISABLED**.



Transmitter Adjustments for the VXL-3s ESC

Before attempting to program your VXL-3s ESC, it is important to make sure that your transmitter is properly adjusted (set back to the factory defaults). Otherwise, you may not get the best performance from your speed control.

The transmitter should be adjusted as follows:

If the transmitter settings have been adjusted, reset them to the factory defaults.

1. Turn the transmitter off.
2. Hold both MENU and SET.
3. Turn the transmitter on.
4. Release MENU and SET. The transmitter LED will blink red.

5. Press SET to clear settings. The LED will turn solid green and the transmitter is restored to default.

VXL-3s Setup Programming (Calibrating your ESC and transmitter)

Read through all of the programming steps before you begin. If you get lost during programming or receive unexpected results, simply unplug the battery, wait a few seconds, plug the battery back in, and start over.

1. Connect a fully charged battery pack to the VXL-3s.
2. Turn on the transmitter (with the throttle at neutral).
3. Press and hold the EZ-Set button (A). The LED will first turn green and then red. Release the EZ-Set button.
4. When the LED blinks RED ONCE, pull the throttle trigger to the full throttle position and hold it there (B).
5. When the LED blinks RED TWICE, push the throttle trigger to the full reverse and hold it there (C).
6. When the LED blinks GREEN ONCE, programming is complete. The LED will then shine green or red (depending on Low-Voltage Detection setting), indicating the VXL-3s is on and at neutral (D).

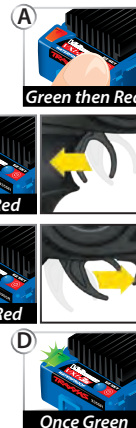

VXL-3s Operation

To operate the speed control and test programming, place the vehicle on a stable block or stand so that all of the drive wheels are off the ground. Disconnect motor wires "A" and "C" (see page 12), this will ensure the motor does not drive the wheels during testing. Do not test programming without disconnecting the motor wires.

Note that in steps 1-7 below, Low-Voltage Detection is ACTIVATED (factory default) and the LED shines green. If Low-Voltage Detection is DISABLED, the LED will shine red instead of green in steps 1-7 below. Never use LiPo batteries while Low-Voltage Detection is disabled.

1. With the transmitter on, press and release the EZ-Set button. The LED will shine green. This turns the VXL-3s on.
2. Apply forward throttle. The LED will turn off until full throttle power is reached. At full throttle, the LED will illuminate green.
3. Move the trigger forward to apply the brakes. Note that braking control is fully proportional. The LED will turn off until full braking power is reached. At full brakes, the LED will illuminate green.
4. Return the throttle trigger to neutral. The LED will shine green.
5. Move the throttle trigger forward again to engage reverse (Profile #1). The LED will turn off. Once full reverse power is reached, the LED will illuminate green.
6. To stop, return the throttle trigger to neutral. Note that there is a programmed delay when changing from reverse to forward. This prevents damage to the transmission on high-traction surfaces.
7. To turn the VXL-3s off, press the EZ-Set button until the LED turns off (.5 seconds).

VXL-3s Profile Selection

The speed control is factory set to Profile #1 (100% forward, brakes, and reverse). To disable reverse (Profile #2) or to allow 50% forward and 50% reverse (Profile #3), follow the steps below. The speed control should be connected to the receiver and battery, and the transmitter should be adjusted as described previously. The profiles are selected by entering the programming mode.

Profile Description

Profile #1 (Sport Mode): 100% Forward, 100% Brakes, 100% Reverse
 Profile #2 (Race Mode): 100% Forward, 100% Brakes, No Reverse
 Profile #3 (Training Mode): 50% Forward, 100% Brakes, 50% Reverse

Selecting Sport Mode (Profile #1: 100% Forward, 100% Brakes, 100% Reverse)

1. Connect a fully charged battery pack to the VXL-3s and turn on your transmitter.
2. With the VXL-3s off, press and hold the EZ-Set button until the LED turns solid green, then solid red and then begins blinking red (indicating the Profile numbers).
3. When the LED blinks red once, release the EZ-Set button.
4. The LED will blink and then turn solid green (Low-Voltage Detection ACTIVE) or red (Low-Voltage Detection DISABLED). The model is ready to drive.

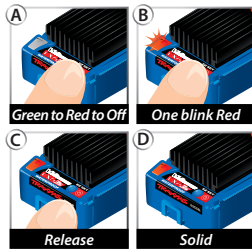

Selecting Race Mode (Profile #2: 100% Forward, 100% Brakes, No Reverse)

1. Connect a fully charged battery pack to the VXL-3s and turn on your transmitter.
2. With the VXL-3s off, press and hold the EZ-Set button until the LED turns solid green, then solid red and then begins blinking red (indicating the Profile numbers).
3. When the LED blinks red twice, release the EZ-Set button.
4. The LED will blink and then turn solid green (Low-Voltage Detection ACTIVE) or red (Low-Voltage Detection DISABLED). The model is ready to drive.

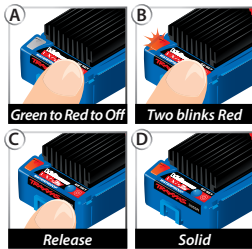

Selecting Training Mode (Profile #3: 50% Forward, 100% Brakes, 50% Reverse)

1. Connect a fully charged battery pack to the VXL-3s and turn on your transmitter.
2. With the VXL-3s off, press and hold the EZ-Set button until the LED turns solid green, then solid red and then begins blinking red (indicating the Profile numbers).
3. When the LED blinks red three times, release the EZ-Set button.
4. The LED will blink and then turn solid green (Low-Voltage Detection ACTIVE) or red (Low-Voltage Detection DISABLED). The model is ready to drive.

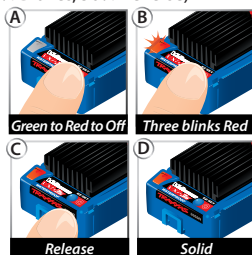

Note: If you missed the mode you wanted, keep the EZ-Set button pressed down and the blink cycle will repeat until the button is released and a Mode is selected.

LED Codes and Protection Modes



• **Solid Green:** VXL-3s power-on light. Low-Voltage Detection is ACTIVATED (LiPo setting).



• **Solid Red:** VXL-3s power-on light. Low-Voltage Detection is DISABLED (NiCad/NiMH setting). **Never use LiPo batteries while Low-Voltage Detection is disabled.**



• **Slow Blinking Red** (with Low-Voltage Detection on): The VXL-3s has entered **Low-Voltage Protection**. When the battery voltage begins to reach the minimum recommended discharge voltage threshold for LiPo battery packs, the VXL-3s will limit the power output to 50% throttle. When the battery voltage attempts to fall below the minimum threshold, the VXL-3s will shut down all motor output. The LED on the speed control will slowly blink red, indicating a low-voltage shutdown. The VXL-3s will stay in this mode until a fully charged battery is connected.



• **Fast Blinking Red:** Thermal Shutdown Protection Stage 1. If the motor has *lower than normal power* and the VXL-3s is hot, the VXL-3s has entered **Stage 1 Thermal Shutdown Protection** to guard against overheating caused by excessive current flow. If the motor has *no power* and the VXL-3s is very hot, the VXL-3s has entered **Stage 2 Thermal Shutdown Protection** and has automatically shut down. Let the VXL-3s cool. Make sure your model is properly geared for the conditions (see page 27).



• **Very Fast Blinking Red:** Thermal Shutdown Protection and Low Voltage Protection (see above) have occurred at the same time.



• **Alternating; Blinks Red then Green:** If the motor has *no power*, the VXL-3s has entered **Over Voltage Protection**. If a battery with too high voltage is used, the VXL-3s will go into a fail-safe mode. **WARNING:** If input voltage exceeds approximately 20-volts, the ESC may be damaged. Do not exceed 12.6 maximum peak input voltage.



• **Blinking Green:** The VXL-3s is indicating the transmitter Throttle Trim (see page 34) is incorrectly set. If the Multi-Function knob is set to throttle trim, then adjust the Throttle Trim to the middle "0" setting.



Patented Training Mode (Profile #3) reduces forward and reverse throttle by 50%. Training Mode is provided to reduce the power output, allowing beginning drivers to better control the model. As driving skills improve, simply change to Sport or Race Mode for full-power operation.



Tip For Fast Mode Changes
 The VXL-3s is set to Profile 1 (Sport Mode) as the default. To quickly change to Profile 3 (Training Mode), with the transmitter on, press and hold the EZ-Set button until the light blinks red three times and then release. For full power, quickly change back to Profile 1 (Sport Mode) by pressing and holding the EZ-Set button until the light blinks red one time and then releasing.



The VXL-3s has built-in programming that prevents accidental activation of reverse while in forward motion and vice-versa. You must come to a complete stop, release the throttle trigger, then apply opposite throttle to engage the motor in the desired direction.

Now it's time to have some fun! This section contains instructions on driving and making adjustments to your model. Before you go on, here are some important precautions to keep in mind.

- Allow the model to cool for a few minutes between runs. This is particularly important when using high capacity battery packs that allow extended periods of running. Monitoring temperatures will extend the lives of the batteries and motors. See page 28 for advanced user information on monitoring temperatures.
- Do not continue to operate the model with low batteries or you could lose control of it. Indications of low battery power include slow operation, sluggish servos (slow to return to center), or ESC shutdown due to the Low-Voltage Detection circuitry. Stop immediately at the first sign of weak batteries. When the batteries in the transmitter become weak, the power light will begin to flash red. Stop immediately and install new batteries.
- Do not drive the model at night, on public streets, or in large crowds of people.
- If the model becomes stuck against an object, do not continue to run the motor. Remove the obstruction before continuing. Do not push or pull objects with the model.
- Because the model is controlled by radio, it is subject to radio interference from many sources beyond your control. Since radio interference can cause momentary losses of control, allow a safety margin of space in all directions around the model in order to prevent collisions.
- Use good, common sense whenever you are driving your model. Intentionally driving in an abusive and rough manner will only result in poor performance and broken parts. Take care of your model so that you can enjoy it for a long time to come.
- When using the supplied optional pinion for top-speed running, limit your driving to paved surfaces only. Running in grass and off-road could cause excessive loads on the electrical system in the model.
- High-performance vehicles produce small vibrations that may loosen hardware over time. Frequently check wheel nuts and other screws on your vehicle to ensure that all hardware remains properly tightened.

About Run Time

A large factor affecting run time is the type and condition of your batteries. The milliamp hour (mAh) rating of the batteries determines how large their "fuel tank" is. A 3000mAh battery pack will theoretically run twice as long as a 1500mAh sport pack. Because of the wide variation in the types of batteries that are available and the methods with which they can be charged, it's impossible to give exact run times for the model.

Another major factor that affects run time is how the model is driven. Run times may decrease when the model is driven repetitively from a stop to top speed and with repetitive hard acceleration.

Tips for Increasing Run Time

- Use batteries with the highest mAh rating you can purchase.
- Use a high-quality peak-detecting charger.
- Read and follow all maintenance and care instructions provided by the manufacturer of your batteries and charger.
- Keep the VXL-3s cool. Get plenty of airflow across the ESC heat sink.
- Use the correct Low-Voltage Detection setting for your battery (see page 18). Low-Voltage Detection can be off for maximum NiMH battery runtime. Never use LiPo batteries while Low-Voltage Detection is turned off.
- Maintain your model. Do not allow dirt or damaged parts to cause binding in the drivetrain. Keep the motor clean.
- Lower your gear ratio. Installing a smaller pinion or larger spur gear will lower your gear ratio, causing less power draw from the motor and battery and reducing overall operating temperatures.

mAh Ratings and Power Output

The mAh rating of the battery can effect your top-speed performance. The higher capacity battery packs experience less voltage drop under heavy load than low mAh rated packs. The higher voltage potential allows increased speed until the battery begins to become discharged.

RUNNING IN WET CONDITIONS

Your new Traxxas model is designed with water-resistant features to protect the electronics in the model (receiver, servos, electronic speed control). This gives you the freedom to have fun driving your model through puddles, wet grass, snow, and through other wet conditions. Though highly water resistant, the model should not be treated as though it is submersible or totally 100% waterproof. Water resistance applies only to the installed electronic components. Running in wet conditions requires additional care and maintenance for the mechanical and electrical components to prevent corrosion of metal parts and maintain their proper function.

Precautions

- **Without proper care, some parts of your model can be seriously damaged due to contact with water. Know that additional maintenance procedures will be required after running in wet conditions in order to maintain the performance of your model. Do not run your model in wet conditions if you are not willing to accept the additional care and maintenance responsibilities.**
- **Not all batteries can be used in wet environments.** Consult your battery manufacturer to see if their batteries can be used in wet conditions. Do not use LiPo batteries in wet conditions.
- The Traxxas TQi transmitter is not water resistant. Do not subject it to wet conditions such as rain.
- Do not operate your model during a rain storm or other inclement weather where lightning may be present.
- Do NOT allow your model to come in contact with salt water (ocean water), brackish water (between fresh water and ocean water), or other contaminated water. Salt water is highly conductive and highly corrosive. Use caution if you plan to run your model on or near a beach.

Before Running Your Vehicle in Wet Conditions

1. Consult the section "After Running Your Vehicle in Wet Conditions" before proceeding. Make sure you understand the additional maintenance required with wet running.
2. The wheels have small holes molded in to allow air to enter and exit the tire during normal running. Water will enter these holes and get trapped inside the tires if holes are not cut in the tires. Cut two small holes (3mm or 1/8" diameter) in each tire. Each hole should be near the tire center-line, 180° apart.

3. Confirm that the RX box O-ring and cover are installed correctly and secure. Make sure the screws are tight and the blue O-ring is not visibly protruding from the edge of the cover.
4. Confirm that your batteries can be used in wet conditions.
5. Use lower gearing (smaller pinion gears, as low as 9T or spur gear as large as 54T) when running in mud, deep puddles, snow, or other similar situations that will restrict the tires and put much higher loads on the motor.

Motor Precautions

- Velineon motor life can be greatly reduced in mud and water. If the motor gets excessively wet or submerged, use very light throttle (run the motor slowly) until the excess water can run out. Applying full throttle to a motor full of water can cause rapid motor failure. Your driving habits will determine motor life with a wet motor. Do not submerge the motor under water.
- Do not gear the motor by temperature when running in wet conditions. The motor will be cooled by water contact and will not give an accurate indication of appropriate gearing.
- Use special care when operating your model in muddy conditions. Stop operating your model if it appears to be straining due to the tackiness of the mud or build-up of mud on the chassis. Do not allow mud to collect on the motor or pack around the motor.

After Running Your Vehicle in Wet Conditions

1. Drain the tires by spinning the tires at high speed to "sling" the water out. One way to do this is to make several high-speed passes on a flat, dry surface, if possible.
2. Remove the batteries.
3. Rinse excess dirt and mud off the truck with low-pressure water, such as from a garden hose. Do NOT use a pressure washer or other high-pressure water. Avoid directing water into the bearings, differentials, etc.
4. Blow off the truck with compressed air (optional, but recommended). Wear safety glasses when using compressed air.
5. Remove the wheels from the truck.
6. Spray all the bearings, drivetrain, and fasteners with WD-40° or similar water displacing light oil.

7. Let the truck stand or you may blow it off with compressed air. Placing the truck in a warm, sunny spot will aid drying. Trapped water and oil will continue to drip from the truck for a few hours. Place it on a towel or piece of cardboard to protect the surface underneath.
8. As a precautionary step, remove the sealed receiver box cover. While unlikely, humidity or tiny amounts of moisture or condensation may enter the receiver box during wet running. This can cause long-term problems with the sensitive electronics in the receiver. Removing the receiver box cover during storage allows the air inside to dry. This step can improve the long-term reliability of the receiver. It is not necessary to remove the receiver or unplug any of the wires.
9. **Additional Maintenance:** Increase your frequency of disassembly, inspection, and lubrication of the following items. This is necessary after extended wet use or if the vehicle will not be used for an extended period of time (such as a week or longer). This additional maintenance is needed to prevent any trapped moisture from corroding internal steel components.
 - **Stub axle housing bearings:** Remove, clean, and re-oil the bearings.
 - **Differentials:** Remove, disassemble, clean, and re-grease the differential components. Use a light coating of wheel bearing grease (from an auto parts store) on the metal gear teeth. Refer to your exploded view diagrams for help with disassembly and reassembly.
 - **Velineon motor:** After operating your model in wet or muddy conditions, remove the motor and clean any mud or dirt from the bearings. To access the rear bearing, remove the plastic cap with thumb pressure, or gently pry the cap off with a flat-blade screwdriver. To prevent corrosion and ensure maximum bearing life, lubricate the bearings with a light oil (available at your local hobby store). Following these steps will extend motor life and maintain peak performance. Be sure to wear eye protection when using spray aerosol cleaners.

RECEIVER BOX: MAINTAINING A WATERTIGHT SEAL Removing and Installing Radio Gear

The unique design of the receiver box allows the removal and installation of the receiver without losing the ability to maintain a watertight seal in the box. The patent-pending wire clamp feature gives you the ability to also install aftermarket radio systems and maintain the watertight features of the receiver box.

Removing the Receiver

1. To remove the wire clamp, remove the two 2.5x12mm socket-head cap screws.
2. To remove the cover, remove the two 3x12mm button-head cap screws.
3. To remove the receiver from the box, unplug the servo cables from the receiver and remove the receiver.

Receiver Installation

1. Using double-sided adhesive foam tape, install the receiver into the box. Make sure the LED light pipe is aligned with the receiver LED.



Note: For best performance, it is recommended that the receiver be installed in the original orientation as shown.

2. Install the servo wires and antenna through the cover and plug the wires into the receiver.
3. Make sure the O-ring is properly seated into the groove in the receiver box so that the cover will not pinch it or damage it any way.
4. Install the cover and tighten the two 3x12mm button-head cap screws securely.
5. Inspect the cover to make sure that the O-ring seal is not visible.
6. Arrange the wires neatly using the wire guides in the receiver box.
7. Apply small bead of silicone grease (part #1647) to the wire clamp.
8. Install the wire clamp and tighten the two 2.5x12mm cap screws securely.



Once you become familiar with driving your model, you might need to make adjustments for better driving performance.

ADJUSTING GEAR MESH

Incorrect gear mesh is the most common cause of stripped spur gears. Gear mesh should be checked and adjusted anytime a gear is replaced. Access the gears by removing the single screw on the gear cover.

To set the gear mesh, loosen the motor screw. Cut a narrow strip of notebook paper and run it into the gear mesh. Slide the motor and pinion gear into the spur gear. Retighten the motor screws and then remove the strip of paper. You should be able to run a fresh strip of paper through the gears without binding them.

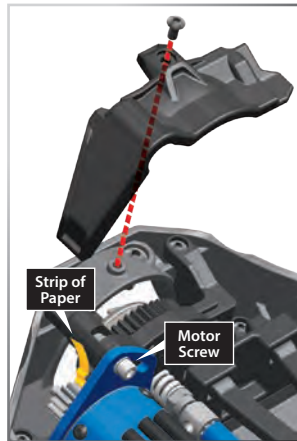

ADJUSTING THE CAMBER

The camber angle of both the front and rear wheels can be adjusted with the camber links (upper turnbuckles). Use a square or right-angle triangle to set the camber accurately. Adjust the front wheels to 1° to 2° of negative camber. In the rear, adjust the wheels to 1° to 2° of negative camber. These adjustments should be set with the truck positioned at its normal ride height.



Static Camber Base Factory Settings
Front: 1° negative camber each side
Rear: 1° negative camber each side

ADJUSTING THE TOE-IN

Toe-in refers to the angle of the wheels as viewed from above. Geometry and alignment specs play an important roll in your model's handling. Take the time to set them correctly. Turn off TSM (see page 17); then, set the steering trim on your transmitter to neutral. Now, adjust your servo and tie rods so that both wheels are pointing straight ahead and are parallel to each other (0° toe-in). This will ensure the same amount of steering in both directions.

Front Toe-In: For increased stability add 1° to 2° of toe in to each front wheel. Use the turnbuckles to adjust the alignment.

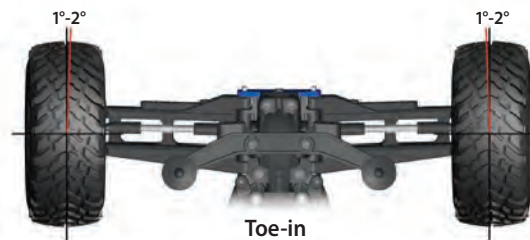

Front Toe Base Factory Settings

Front: 0°
Rear: 2.5° toe-in each side

Rear Toe-In: You will notice that the Slash 4x4 Ultimate's rear wheels point inward slightly, which aids in stability. This is called toe-in, and is measured in degrees. If the wheels point straight ahead, parallel with the chassis' centerline, then the wheels have "zero toe-in." The Slash 4x4 Ultimate is equipped with aluminum rear stub axle carriers that provide 4° of rear toe-in. You will note that the axle carriers are labeled "L" and "R," to indicate left and right. The axle carriers may be installed on the opposite sides (L on

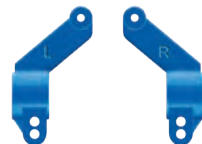

Aluminum axle carriers installed as labeled: 4° toe-in

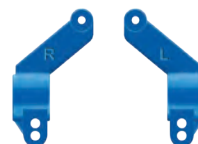

Aluminum axle carriers reversed: 1° toe-in



Plastic axle carriers (not L/R dependent): 2.5° toe-in



All of the toe links are installed on the truck so the left-hand thread indicators point to the same direction. This makes it easier to remember which way to turn the wrench to increase or decrease toe link length (the direction is same at all four corners). Note that the groove in the hex indicates the side of the toe link with the left-hand threads.

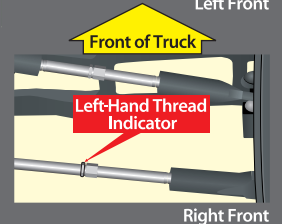
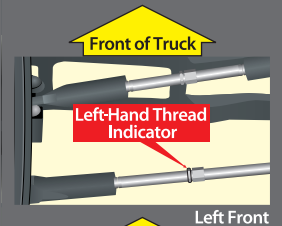



To achieve a good starting point for the slipper clutch in this model, remove the slipper gear assembly from your model (see page 26 for instructions) and tighten the slipper clutch adjusting nut clockwise until the slipper clutch adjusting spring fully collapses (do not over tighten), and then turn the slipper clutch nut counterclockwise one full turn.

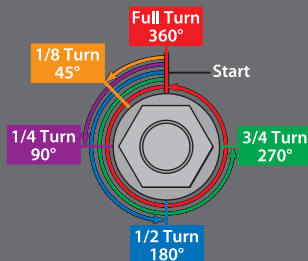

Do not run your model with the slipper clutch adjusting spring fully compressed. The minimum recommended slipper clutch setting is 1/2 turn counterclockwise from fully compressed.

the right side, R on the left side) to provide 1° of toe-in. Slash 4x4 Ultimate can also use plastic rear stub axle carriers (part #1952, sold separately), which offer 2.5° of toe-in. They can be installed on either side of the truck, as they are not left/right specific.

In general, increasing toe-in improves stability, while reducing toe-in may help “loosen up” the truck’s handling to improve corner speed, especially on high-grip tracks. Experiment to see what works best for your track and driving style.

SHOCK MOUNTING POSITIONS

Big bumps and rough terrain require a softer suspension with the maximum possible suspension travel and ride height. Racing on a prepared track or on-road use requires a lower ride height and firmer, more progressive suspension settings. The more progressive suspension settings help reduce body roll (increased roll stiffness), dive during braking, and squat during acceleration.



The suspension of your model has been set up for off-road performance (position 2 on the front suspension arms and position 3 on the rear suspension arms). If you plan on driving on hard surfaces the following changes should be made:

1. Move the front shocks to position 3 on the suspension arms.
2. Move the rear shocks to position 4 or 5 on the suspension arms.
3. Reduce the ride height by loosening the upper spring pre-load spacer.
4. Position 1 is not recommended for front or rear.

CENTERING YOUR SERVO

If you have removed the servo horn from your model’s steering servo, or the servo has been removed for service or cleaning, the servo must be re-centered prior to installation of the servo horn or installation of the servo in the model.

1. Remove the front module from the vehicle to access the steering servo.

2. Connect the steering servo to channel 1 on the receiver. Connect the electronic speed control (ESC) to channel 2. The white wire on the servo lead is positioned towards the receiver’s LED.
3. Turn the transmitter power switch on. Make certain the transmitter’s batteries are not depleted.
4. Turn off TSM (see page 17).
5. Turn the transmitter’s steering trim knob to the center “0” position.
6. Disconnect motor wires “A” and “C” (see page 12) to prevent the motor from turning during the next steps. Connect a fresh battery pack to the speed control and turn on the ESC (see page 18). The servo’s output shaft will automatically jump to its center position.
7. Install the servo horn onto the servo output shaft. The servo horn should be aligned one spline clockwise from perpendicular alignment with the servo case (not the chassis).
8. Check servo operation by turning the steering wheel back and forth to ensure that the mechanism has been centered properly and you have equal throw in both directions. Use the transmitter’s steering trim knob to fine-tune the position of the servo horn so the model tracks straight when the steering wheel is at neutral.

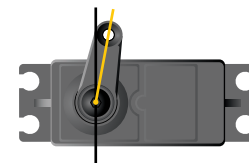

ADJUSTING THE SLIPPER CLUTCH

The model is equipped with an adjustable slipper clutch, which is built into the large spur gear. The purpose of the slipper clutch is to regulate the amount of power sent to the wheels to prevent tire spin. When it slips, the slipper clutch makes a high-pitch, whining noise. To adjust the slipper, remove the slipper gear assembly from your model (see page 26 for instructions), and turn the adjusting nut clockwise to tighten or counterclockwise to loosen. Adjust the slipper so that you can hear it slip for a moment from a standing, full throttle start. (Learn more about adjusting the slipper clutch in the sidebar.)

Your model requires timely maintenance in order to stay in top running condition. **The following procedures should be taken very seriously.**

Frequently inspect the vehicle for obvious damage or wear. Look for:

1. Cracked, bent, or damaged parts
2. Check the wheels and steering for binding.
3. Check the operation of the shock absorbers.
4. Check the wiring for any frayed wires or loose connections.
5. Check the mounting of the receiver and servo(s) and speed control.
6. Check the tightness of the wheel nuts with a wrench.
7. Check the operation of the radio system, especially the condition of the batteries.
8. Check for any loose screws in the chassis structure or suspension.
9. Check the operation of the steering servo and ensure that it is not binding.
10. Inspect the gears for wear, broken teeth, or debris lodged between the teeth.
11. Check the tightness of the slipper clutch.

Other periodic maintenance:

• **Slipper clutch pads**

(friction material):

Under normal use, the friction material in the slipper clutch should wear very slowly. If the thickness of any one of the slipper clutch pads is 1.8mm or less, the friction disc should be replaced. Measure the pad thickness using calipers or measuring against the diameter of the 1.5 and 2.0mm hex wrenches provided with the model.



- **Chassis:** Keep the chassis clean of accumulated dirt and grime. Periodically inspect the chassis for damage.

- **Suspension:** Periodically inspect the model for signs of damage, such as bent or dirty suspension pins, bent turnbuckles, loose screws, and any signs of stress or bending. Replace components as needed.
- **Steering:** Over time, you may notice increased looseness in the steering system. The tie rod ends may wear out from use (Traxxas Parts #2742 and #5525). Replace these components as needed to restore factory tolerances.
- **Shocks:** Keep the oil level in the shocks full. Use only 100% pure silicone shock oil to prolong the life of the seals. If you are experiencing leakage around the top of the shock, inspect the bladder in the top cap for signs of damage or distortion from overtightening. If the bottom of the shock is leaking, then it is time for a rebuild. The Traxxas rebuild kit for two shocks is part #7463.
- **Driveline:** Inspect the driveline for signs of wear, such as worn drive yokes, dirty axle half shafts, and any unusual noise or binding. If a U-joint pops apart then it is time to replace the part. Remove the gear cover. Inspect the spur gear for wear and check the tightness of the set screws in the pinion gears. Tighten, clean, or replace components as needed.

Storage

When you are through running the model for the day, blow it off with compressed air or use a soft bristled paint brush to dust-off the vehicle.

Always disconnect and remove the battery from the model whenever the model is stored. If the model will be stored for a long time, then also remove the batteries from the transmitter.



Always wear eye protection when using compressed air or spray cleaners and lubricants.



High-performance vehicles generate small vibrations while driving. These vibrations may loosen hardware over time and require attention. Always check your wheel nuts and other hardware and tighten or replace when necessary.

Suspension and slipper clutch assembly removal

The Slash 4X4 Ultimate was designed with ease of disassembly in mind. The entire front and rear suspension assemblies can be removed from the chassis fully intact with the removal of only a few screws. Refer to the exploded views included in the Slash 4X4 Ultimate Service and Support Guide for complete assembly diagrams.

- **Removing the front suspension module**

1. Remove the 3x15 button-head cap screw from the steering link under the chassis.
2. Remove the two 3x6 flat-head cap screws from the front chassis.
3. Remove the two 4x12 button-head cap screws from the front of the chassis.
4. Remove the two 4x10 button-head cap screws from the top of the chassis.
5. Pull the front suspension assembly away from the chassis.

- **Removing the rear suspension module
(Slipper clutch assembly removal)**

1. Remove the two 4x12 button-head cap screws from the top of the chassis.
2. Remove the two 4x14 button-head cap screws from the bottom of the chassis.
3. Pull the rear suspension assembly away from the chassis.
4. The slipper clutch assembly can now be removed.

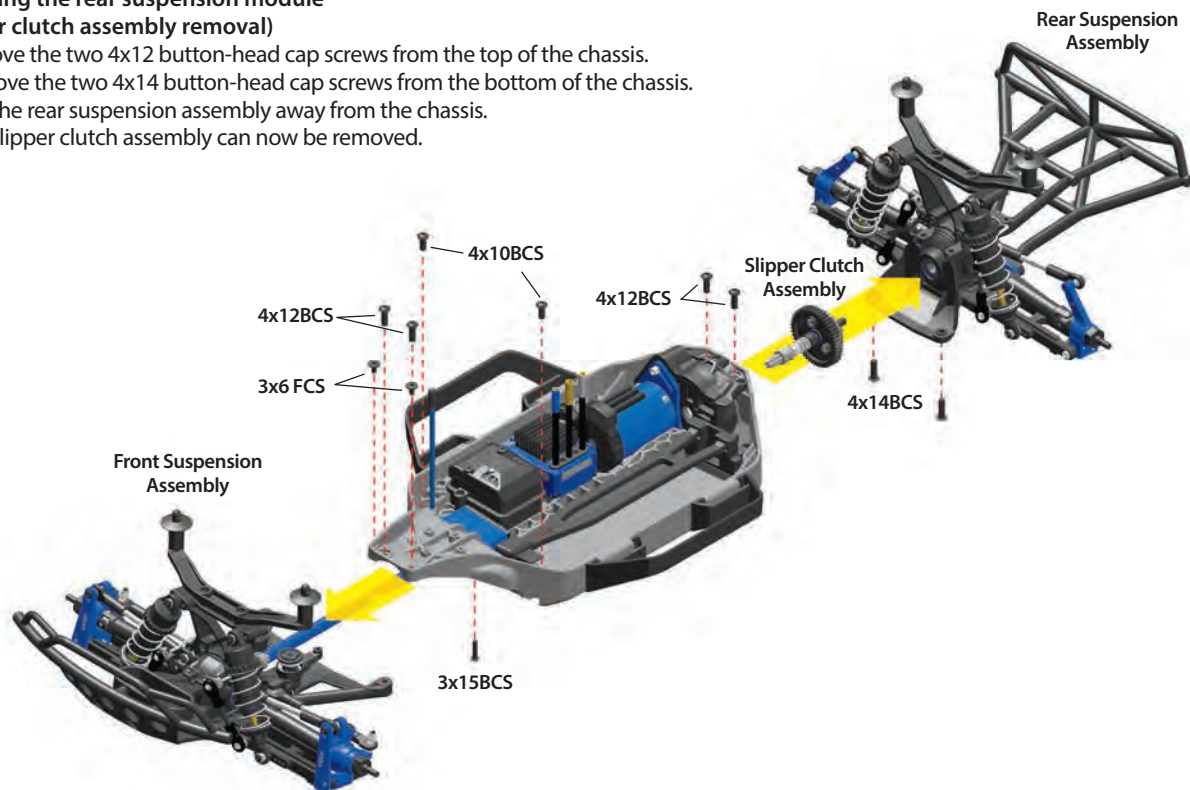



CAMBER GAIN

Slash 4X4 Ultimate has provisions for adjusting the camber gain geometry of the front and rear suspension. "Camber gain" refers to an increase in camber angle as the suspension is compressed. The camber gain of the vehicle can be changed by moving the camber link attachment to a different horizontal mounting position. Adjusting the camber gain will alter the tire contact patch as the suspension is compressed. Making the camber link shorter will increase the camber gain. This makes the vehicle more stable over bumps, but reduces traction on smooth surfaces. Lengthening the camber links has the opposite effect.

Front Camber Gain

To increase the camber gain on the front suspension, move the inner camber link ends out to Position 3. Position 4 is the stock setting.

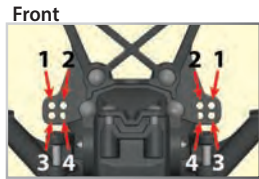

Rear Camber Gain

To increase the camber gain on the rear suspension, move the inner camber link ends out to a different attachment hole (Position 4 in the image). Position 5 is the stock setting).

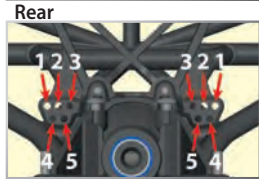

Once you make adjustments to the camber gain, you may need to re-adjust the static camber to suit your tuning needs.

ROLL CENTER

Slash 4X4 Ultimate has provisions for adjusting the roll center geometry of the front and rear suspension. Roll center refers to the virtual axis around which the chassis will roll when subjected to cornering forces. The roll center of the vehicle can be raised by mounting the inner ends of the camber links in a lower position. Raising the roll center will effectively increase the roll stiffness of the vehicle (similar to installing sway bars). Adding roll resistance to one end of the vehicle will tend to add traction to the opposite end. For example, increasing roll resistance in the rear will provide more traction for the front wheels

and potentially more steering. Raising the roll center on the front and rear equally will increase overall roll resistance without changing the handling balance. The default factory locations are designed to make the truck easier and more forgiving to drive and less likely to traction roll in turns.

Front Roll Center

To lower the roll center on the front suspension, move the inner camber link ends up to a different attachment hole (Position 1 or 2 - Position 4 is the stock setting). To lower the roll center further, move the outer camber link ends to the lower position on the C-hub.

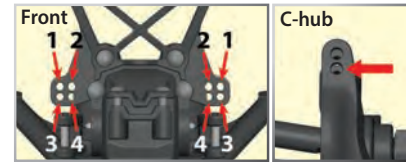

Bump steer correction - "Bump steer" refers to unwanted steering inputs caused by suspension movement. Slash 4X4's suspension geometry is designed to minimize bump-steer. If you are using the upper hole on the C-hub (image A) and either of the two lower holes on the shock tower (positions 3 or 4 in "Front" image), the tie rod ball should be oriented with the large flat end on top (stock position - image B). When using any other combination of camber link attachment points, the tie rod ball should be oriented with the large flat end on the bottom (C).

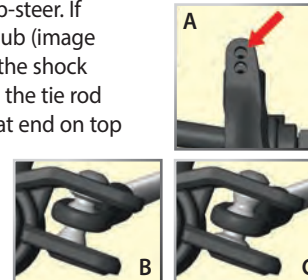

Rear Roll Center

To lower the roll center on the rear suspension, relocate the inner camber links to one of the upper holes (position 1, 2, or 3 in image) in the upper row of the rear camber link attachment.

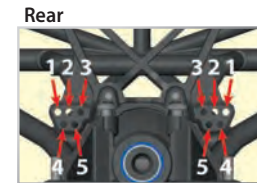

Once you make adjustments to the roll center, you may need to re-adjust the static camber to suit your tuning needs.

Gearing Compatibility Chart:
The chart below shows recommended gear combination ranges for your model.

		Spur Gear		
		50	52	54
Pinion Gear	9	-	16.44	17.08
	10	-	14.80	15.37
	11	12.94	13.45	13.97
	12	11.86	12.33	12.81
	13	10.95	11.38	11.82
	14	10.16	10.57	10.98
	15	9.49	9.87	10.25
	16	8.89	9.25	9.61
	17	8.37	8.71	9.04
	18	7.91	8.22	8.54
	19	7.49	7.79	8.09
20	7.12	7.40	7.68	
21	6.78	7.05	7.32	
22	6.47	6.73	-	
23	6.19	6.43	-	
24	5.93	-	-	
25	5.69	-	-	
26	-	-	-	

Thick black border indicates stock settings.

- Out of box setup, recommended for most running, 6 or 7-cell NiMH, 2S LiPo
- Recommended gear range for 6 or 7-cell NiMH and 2S LiPo
- Included optional gearing, for high-speed NiMH running only
- Optional gearing (not included), for high-speed LiPo running only
- Fits, not recommended
- Does not fit

Blue, purple, and red gearing ranges require part modification or the use of aftermarket brushed 540 motors to accommodate the gearing selection

- Requires removal or modification of plastic motor end cap for proper fit
- Requires removal or modification of center shaft cover for proper fit
- For aftermarket 540 motors; center shaft cover removed or modified



Velineon 3500 Specs

Type:
Sensorless brushless

RPM/volt:
3500 (10-turn)

Magnet type:
Ultra High-Temperature Sintered Neodymium

Connection type:
3.5mm bullet

Wire size:
12 Gauge

Max RPM:
50,000

Diameter:
36mm (1.42) (540 size)

Length:
55mm (2.165)

Weight:
262g (9.24oz)



Always use the proper length motor bolts. The standard motor mounting bolts are 3x8mm. Using motor bolts that are too long can interfere with the motor's rotation and damage the motor's internals!



The VXL-3s features Locked Rotor Protection. The VXL-3s checks to make sure the motor is turning. If the motor is locked or damaged, the ESC will enter fail-safe until the motor is free to rotate.

GEARING

One of the more significant advantages to your model's transmission is the extremely wide range of available gear ratios. Changing the gearing allows you to fine tune the speed of the model and control the temperatures of the battery pack and motor. Use a lower gear ratio (numerically larger) to reduce current draw and temperatures. Use a higher gear (numerically lower) to increase top speed. Use the following formula to calculate the overall ratio for combinations not listed on the gear chart:

$$\frac{\text{\# Spur Gear Teeth}}{\text{\# Pinion Gear Teeth}} \times 2.85 = \text{Final Gear Ratio}$$

When using higher gear ratios, it is important to monitor the temperatures of the battery and motor. If the battery is extremely hot (150°F) and/or the motor is too hot to touch (200°F), your model is probably over-gearred and drawing too much current. This temperature test assumes that the model is close to factory stock weight and operates freely with no excessive friction, dragging, or binding, and the battery is fully charged and in good condition. **Note:** Check and adjust gear mesh if a spur and/or pinion gear is changed.

This model is equipped with a Velineon 3500 motor. The gear combination that comes stock on each model provides good overall acceleration and top speed. If you want more top speed, install the included optional large pinion gear (more teeth). **The included optional large pinion gear is intended for high-speed running on hard surfaces, and this gearing is not recommended for off-road or repetitive starting and stopping.**

LIPO BATTERIES

LiPo batteries are intended only for the most advanced users that are educated on the risks associated with LiPo battery use. It is critical to follow all instructions supplied by the battery manufacturer and the charger manufacturer for proper charging, use, and storage of LiPo batteries. Make sure you understand how to use your LiPo batteries. See *Safety Precautions and warnings* on page 4 for more information.

TEMPERATURES AND COOLING

Monitoring temperatures will extend the lives of the batteries and motors. There are many options available that will help you monitor temperatures and cool your components .

Temperature sensor

To accurately monitor motor temperature and prevent overheating, a telemetry temperature sensor (part #6523) can be installed on the motor to continually monitor temperature as you drive. Generally, try to keep your motor below 200° F. If necessary, increase airflow to the motor by cutting out the rear of the body or windshield.



Heat sink cooling fan

The VXL-3s is equipped with an additional connector to supply power to an optional heat sink cooling fan (part #3340). The optional heat sink cooling fan can assist in cooling the VXL-3s in high current motor applications.



Slash 4X4	35+mph	40+mph	40+mph	45+mph	60+mph
Pinion/Spur	13/54*	18/54**	19/54	13/54*	19/54
Battery	7-Cell NiMH	7-Cell NiMH	2S LiPo	3S LiPo	3S LiPo
Nominal Voltage	8.4V	8.4V	7.4V	11.1V	11.1V
mAh	4000+ mAh	4000+ mAh	4000+ mAh	5000+ mAh	5000+ mAh
Skill Level	1	2	4	4	5

* Stock Gearing

** Included Optional Pinion



TUNING THE SEALED GEAR DIFFERENTIALS

The action of the Slash 4X4 Ultimate's front and rear gear differentials can be tuned for different driving conditions and performance requirements, without major disassembly or removal of the suspension system.

From the factory, the differentials are sealed to maintain consistent long-term performance. Changing the oil in the differential with either lower or higher viscosity oil will vary the performance characteristics of the differentials. Changing to a higher viscosity oil in the differential will reduce the tendency for motor power to be transferred to the wheel with the least traction. You may notice this when making sharp turns on slick surfaces. The unloaded wheels on the inside of the turn have the least traction and tend to spin up to extremely high rpms. Higher viscosity (thicker) oil causes the differential to act like a limited-slip differential, distributing more equal power to the left and right wheels.

Slash 4X4 Ultimate will generally benefit from higher viscosity oil when climbing or racing on low traction surfaces. **Note:** Heavier oil will allow power to be transferred even with one or more tires off the ground. This can make the vehicle more likely to overturn on high-traction surfaces.

From the factory, the front differential is filled with SAE 30,000W (30K) viscosity silicone oil. The rear differential is filled with grease, but can also be tuned with silicone differential oil. Only use silicone oil in the differentials. Traxxas offers silicone differential fluid in a variety of viscosities:

Part #5135: 10K Part #5136: 30K Part #5137: 50K
 Part #5130: 100K Part #5039: 500K

Follow the steps below to access and refill the front and rear differentials:

Front differential:

1. Remove the two 3x15mm button-head screws that secure the top bumper mount to the differential (diff) case.
2. Turn the chassis over and remove the three 4x10mm countersunk screws that hold bumper/skid plate to the bulkhead. The two rear screws do not need to be removed.
3. Slide bumper assembly off of the chassis.
4. Remove 3x15mm button-head screw from diff tie bar.
5. Slide tie bar off truck.

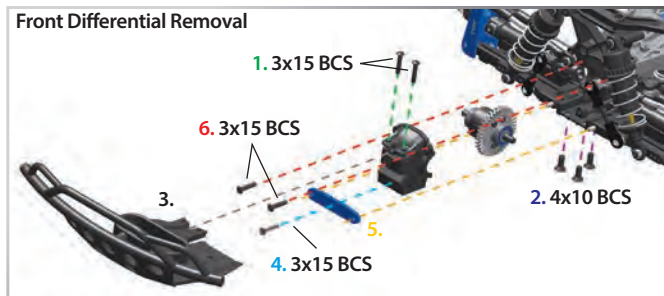

6. Remove two 3x15mm button-head screws from the differential cover. Do not remove the two screws that secure the shock tower.
7. Use a 1.5mm hex wrench to remove the two screw pins that hold the driveshaft yokes to the differential output shafts. Remove the differential cover and slide the differential out of the front of the case.
8. To reinstall the differential, reverse the steps.

Rear differential:

1. Remove the two 3x6mm flat-head sway bar screws.
2. Remove the two 3x20mm button-head screws that secure the top bumper mount to the differential case.
3. Turn the chassis over and remove the two 3x12mm countersunk screws that hold the bumper/skid plate to the bulkhead. The two front screws do not need to be removed.
4. Remove the 3x20mm button-head screw from the bumper mount and tie bar.

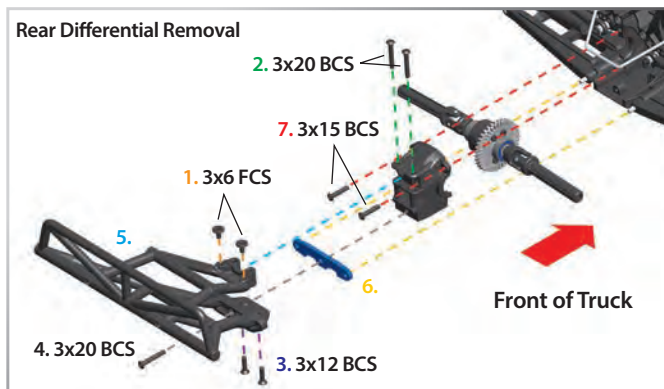

5. Slide the bumper assembly off of the chassis.
6. Remove the tie bar from the chassis.
7. Remove the two 3x15mm button-head screws from the differential cover. Do not remove the two screws that secure the shock tower.
8. Remove the differential cover and slide the differential out of the front of the case.
9. To reinstall the differential, reverse the steps.

Refilling the differentials:

1. Remove the four 2.5x8mm screws from the differential case and carefully pull the differential case halves apart. Work over a towel to collect any fluid that drips from the differential.
2. Drain the fluid from the differential. You may wish to remove the spider gears from the differential to make this easier.
3. Place the spider gears back into the differential case, if you removed them. Fill the diff case with fluid until it the spider gears are submerged half way.
4. Rejoin the differential case halves, using care to align the screw holes. Be sure the rubber gasket is in place, or the differential may leak.
5. Install the 2.5x8mm screws and tighten securely.

Center differential

The optional center differential (part #6814, sold separately) allows the power from the motor to be transferred to the front and rear differentials independently from one another. When the rear wheels are under more load than the front wheels, more power will be transmitted to the front wheels. This is very beneficial on rough terrain and makes hard acceleration from low speeds easier to control by keeping the nose down. The center differential is assembled with 100K differential lube from the factory. This viscosity will be a good base point for most conditions.

1. Locate and remove the two 4x12mm button head machine screws from the top rear of the chassis and the two 4x14mm button head machine screws from the bottom of the rear suspension bulkhead (See page 26 for reference).
2. Remove the modular rear end from the chassis by sliding it backward away from the chassis. This is to access the spur gear/slipper unit. Remove the spur gear/slipper unit from the rear of the chassis.

3. Insert the included center differential unit into the rear of the chassis (where the spur gear/slipper unit was removed). Stand the chassis up on the front bumper to hold the rear gear steady and line it up with the pinion gear. The splined shaft adapter must key into the aluminum center drive shaft.
4. Attach the rear end unit to the chassis keying in the rear output shaft of the center differential with the opening in the rear differential. Secure the assembly with the same four button-head screws.

Tip: Rotate the rear wheels slowly while attaching the rear end to the chassis to properly set the rear output shaft of the center differential into the rear differential. You should feel the rear end set into place. The rear skid plate should lock into the bottom of the chassis.

TUNING AND MAINTAINING THE SHOCKS

Slash 4X4 Ultimate features high-performance GTR shocks that utilize friction-reducing titanium nitride shafts and hard-anodized bodies with PTFE-coated bores to provide the ultimate in precise damping control. The shocks are filled with 30W silicone fluid. You may wish to install lower-viscosity (“thinner”) or higher-viscosity (“thicker”) fluid to alter damping performance to suit your track, terrain, or driving style. Damping can also be altered by changing the pistons inside the shocks. The front piston is a 2-hole with 1.5mm diameter holes. The rear piston is a 2-hole with 1.6 diameter holes.

Shock Oil

The 4 oil-filled aluminum shocks (dampers) effectively control the suspension movement by preventing the wheels and tires from continuing to “bounce” after rebounding from a bump. Changing the oil in the shocks can vary the suspension damping effect. Changing the oil to a higher viscosity oil will increase damping. Lowering the viscosity of the oil will cause the suspension damping to be reduced. Damping should be increased (with higher viscosity oil) if the model is bottoming easily over jumps. Damping should be decreased (with thinner viscosity oil) if the model is hopping over small bumps and feels unstable. The viscosity of shock oil is affected by extremes in operating temperature; an oil of certain viscosity will become less viscous at higher temperatures and more viscous at lower temperatures. Operating in regions with cold temperatures may require lower viscosity oil. From the factory, the shocks are filled with SAE-30W silicone oil. Only use 100% silicone oil in the shock.

Replacing Shock Oil

For easier service, the shocks should be removed from the vehicle and disassembled to change the oil.

1. Remove the lower spring retainer and shock spring.
2. Remove the upper shock cap using the shock wrench and suspension multi-tool (A).
3. Empty the used shock oil from the shock body.
4. Fill the shock with new silicone shock oil up to the top of the shock body.
5. Slowly move the piston up and down (always keeping it submerged in oil) to release the air bubbles. Let the shock sit for a few minutes to allow any remaining air bubbles to surface.
6. Slowly thread the upper cap with the installed shock bladder onto the shock body with the suspension multi-tool. The excess oil will bleed out of the small hole in the shock cap.
7. Tighten the shock cap until snug.
Use the included steel shock wrench to hold onto the shock body while tightening (A).

Shock disassembly

The shocks must be removed from the vehicle and disassembled to change the pistons. Use the shock exploded views included with the model to aid in the assembly process.

1. Remove the spring and lower spring retainer from the shock.
2. Remove the shock cap and empty the shock body of shock oil (A).
3. Remove the lower cap and the X-ring from the shock body (B).
4. Use side cutters to grip the shock shaft just above the rod end. Remove the rod end from the shock shaft using the suspension multi-tool (C).
5. Remove the shock shaft with piston from the shock body out through the top of the shock body.

Multi-tool Shock Functions



A. Tighten/Loosen Upper Cap



B. Tighten/Loosen Lower Cap



C. Remove/Install Rod End

Shock assembly

1. Replace the stock piston with desired optional piston. Be careful not to lose the small washer located below the piston.
2. Position the new piston onto the shock shaft above the small washer. Grip the threads of the shaft with side cutters or needlenose pliers and tighten the nut with the 4-way wrench to secure the assembly (D).
3. Insert the shock shaft assembly through the shock body until the piston bottoms out.
4. Lubricate the shaft and X-ring with silicone oil.
5. Install the X-ring over the shaft and into the bore of the shock body.
6. Install the lower cap using the suspension multi-tool (B).
7. Grip the shaft close to the threads with needlenose pliers or side cutters and thread the rod end onto the shock shaft until the rod end bottoms out (C).
8. Fill the shock with new silicone shock oil up to the top of the shock body. Slowly move the piston up and down (always keeping it submerged in oil) to release the air bubbles. Let the shock sit for a few minutes to allow any remaining air bubbles to surface.
9. Slowly thread the upper cap with the installed shock bladder onto the shock body with the suspension multi-tool. The excess oil will bleed out of the small hole in the shock cap. Tighten the shock cap until snug. Use the included steel shock wrench to hold onto the shock body while tightening (A).
10. Reinstall the spring and lower retainer.



D. Piston Installation/Removal

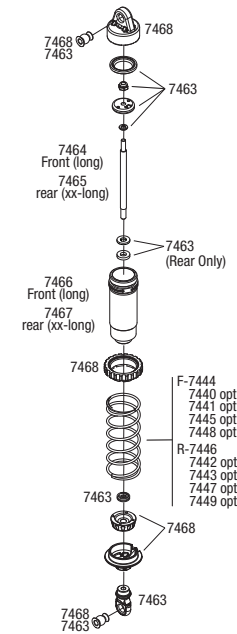

i Optional shock springs available from Traxxas. Refer to your parts list for a complete part number listing. Higher rate springs are stiffer. Springs can be identified by dots of color on one end.

Shock Piston Sizes



1.5mm Front 1.6mm Rear

SWAY BAR SETTINGS AND ADJUSTMENTS

- Adjust the sway bar links so the sway bars are level (parallel to the ground) when the truck is on the ground and the suspension is at rest (normal ride height). This allows equal sway bar travel in both unloaded and loaded suspension conditions. Always adjust the left and right sway bar links equally to prevent suspension tweak.

- The adjustable hollow balls can be moved closer to or farther from the sway bar mount (pivot point) to increase torsion response and fine tune the sway bar's response for different track conditions.

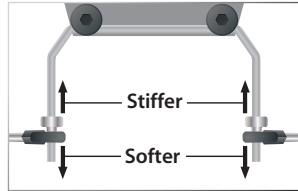

Closer to the pivot point results in a stiffer setup, farther from the pivot point will result in softer sway bar response.

For smooth surfaces with high traction:

- Adjust linkage placement for stiffer response (closer to the sway bar mount).

For rough surfaces with low traction:

- Adjust linkage placement for softer response (farther from the sway bar mount).

To reduce understeer (pushing in corners):

- Adjust front linkage placement for softer response (farther from the sway bar mount).
- Adjust rear linkage placement for stiffer response (closer to the sway bar mount).

To reduce oversteer (loose in corners):

- Adjust front linkage placement for stiffer response (closer to the sway bar mount).
- Adjust rear linkage placement for softer response (farther from the sway bar mount).

If you have questions or need technical assistance, call Traxxas at

1-888-TRAXXAS

(1-888-872-9927) (U.S. residents only)

The model's TQi transmitter is equipped with the Traxxas Link Wireless Module. This innovative accessory transforms your Apple® iPhone®, iPad®, iPod touch®, or Android™ device into a powerful tuning tool that equips your TQi with an intuitive, high-definition, full-color graphical user interface.

Traxxas Link

The powerful Traxxas Link™ App (available in the Apple App StoreSM or on Google Play™) gives you complete control over the operation and tuning of your Traxxas model with stunning visuals and absolute precision. With the installed Traxxas Link telemetry sensors on the model, Traxxas Link displays real-time data such as speed, RPM, temperature, and battery voltage.

Intuitive iPhone, iPad, iPod touch, and Android interface

Traxxas Link makes it easy to learn, understand, and access powerful tuning options. Control Drive Effects settings such as TSM assistance percentage; steering and throttle sensitivity; steering percentage; braking strength; and throttle trim by simply touching and dragging the sliders on the screen.



Tap and slide to adjust TSM, Steering Sensitivity, Throttle Trim, Braking Percent, and more!

Real-Time Telemetry

With the installed telemetry sensors, the Traxxas Link dashboard comes to life showing you speed, battery voltage, RPM, and temperature. Set threshold warnings and log maximums, minimums, or averages. Use the recording function to document your dashboard view, with sound, so that you can keep your eyes on your driving and not miss a single apex.



The customizable Traxxas Link dashboard delivers real-time rpm, speed, temperature, and voltage data.

Manage up to 30 Models with Traxxas Link

The TQi radio system automatically keeps track of what vehicles it has bound to and what settings were used for each--up to 30 models total! Traxxas Link provides a visual interface to name the models, customize their settings, attach profiles, and lock them into memory. Simply choose a model and any previously bound transmitter, power them up, and start having fun.

Pairing the TQi transmitter with the Traxxas Link Wireless Module and the Traxxas Link App for the first time:

1. Turn the transmitter switch on.
2. Open the Traxxas Link App on your mobile device. Touch the Garage button, and then touch the Wireless Module button (A).
3. Press the button on the Traxxas Link Wireless Module. The blue LED on the module will blink (B).

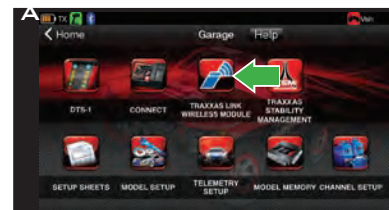

4. Within 10 seconds, touch the "Search for Traxxas Link Wireless Module" button on your mobile device (C).



5. The Bluetooth® icon in the status bar will turn blue, and the blue LED on the module will glow solid blue (D).
6. The Traxxas Link Wireless Module and the Traxxas Link App are now paired, and will automatically connect when the transmitter is turned on and the app is running.

TRAXXAS LINK MODULE LED CODES

LED Color / Pattern	Name	Notes
Blue LED off	Connecting mode	Traxxas Link App is not running on a paired device.
Slow blue (0.5 sec on / 0.5 sec off)	Pairing mode	See above for information on pairing the module with Traxxas Link App.
Solid blue	Connected	See page 15 for information on how to use your transmitter controls.



Throttle Trim Seek Mode

When the Multi-Function knob is set to throttle trim, the transmitter remembers the throttle trim setting. If the throttle trim knob (Multi-Function knob) is moved from the original setting while the transmitter is off, or while the transmitter was used to control another model, the transmitter ignores the actual position of the trim knob. This prevents the model from accidentally running away. The LED on the face of the transmitter will rapidly blink green and the throttle trim knob (Multi-Function knob) will not adjust the trim until it is moved back to its original position saved in memory. To restore throttle trim control, simply turn the Multi-Function knob either direction until the LED stops blinking.



Fail-safe

Your Traxxas radio system is equipped with a built-in fail-safe function that returns the throttle to its last saved neutral position in the event of a signal loss. The LED on the transmitter and the receiver will rapidly flash red.



Starting Over:

Restoring Factory Defaults

When programming your TQi transmitter, you may feel the need to start over with a clean slate. Follow these simple steps to restore the factory settings:

1. Turn the transmitter off.
2. Hold both MENU and SET.
3. Turn the transmitter on.
4. Release MENU and SET. The transmitter LED will blink red.
5. Press SET to clear settings. The LED will turn solid green and the transmitter is restored to default.

Available Tuning Adjustments

The following items can be adjusted most easily using your mobile device and the Traxxas Link application. All the features described below may also be accessed using the MENU and SET buttons on the transmitter and observing signals from the LED. An explanation of the menu structure follows on page 37.

Your Traxxas transmitter has a programmable Multi-Function knob that can be set to control various advanced transmitter functions (set to Traxxas Stability Management by default, see page 17). Experiment with the settings and features to see if they can improve your driving experience.

Steering Sensitivity (Exponential)

The Multi-Function knob on the TQi transmitter can be set to control Steering Sensitivity (also known as exponential). The standard setting for Steering Sensitivity is “normal (zero exponential),” with the dial full left in its range of travel. This setting provides linear servo response: the steering servo’s movement will correspond exactly with the input from the transmitter’s steering

wheel. Turning the knob clockwise from center will result in “negative exponential” and decrease steering sensitivity by making the servo less responsive near neutral, with increasing sensitivity as the servo nears the limits of its travel range. The farther you turn the knob, the more pronounced the change in steering servo movement will be. The term “exponential” comes from this effect; the servo’s travel changes exponentially relative to the input from the steering wheel. The exponential effect is indicated as a percentage—the greater the percentage, the greater the effect. The illustrations below show how this works.

Normal Steering Sensitivity (0% exponential):

In this illustration, the steering servo’s travel (and with it, the steering motion of the model’s front wheels) corresponds precisely with the steering wheel. The ranges are exaggerated for illustrative purposes.

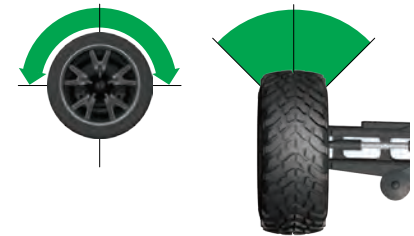

TRANSMITTER LED CODES

LED Color / Pattern	Name	Notes
Solid green	Normal Driving Mode	See page 15 for information on how to use your transmitter controls.
Slow red (0.5 sec on / 0.5 sec off)	Binding	See page 16 for more information on binding.
Flashing fast green (0.1 sec on / 0.15 sec off)	Throttle Trim Seek Mode	Turn the Multi-Function knob right or left until the LED stops flashing. See sidebar for more information.
Flashing medium red (0.25 sec on / 0.25 sec off)	Low Battery Alarm	Put new batteries in the transmitter. See page 13 for more information.
Flashing fast red (0.125 sec on / 0.125 sec off)	Link Failure / Error	Transmitter and receiver are no longer bound. Turn the system off and then back on to resume normal operation. Find source of the link failure (i.e., out of range, low batteries, damaged antenna).
Programming Patterns		
Counts out number (green or red) then pauses	Current menu position	See Menu Tree for more information.
X8	Fast green 8 times	Menu setting accepted (on SET)
X8	Fast red 8 times	Menu SET invalid
		User error such as trying to delete a locked model.

RECEIVER LED CODES

LED Color / Pattern	Name	Notes
Solid green	Normal Driving Mode	See page 15 for information on how to use your transmitter controls.
Slow red (0.5 sec on / 0.5 sec off)	Binding	See page 16 for more information on binding.
Flashing fast red (0.125 sec on / 0.125 sec off)	Fail-Safe / Low-Voltage Detect	Consistent low voltage in the receiver triggers Fail-Safe so there is enough power to center the throttle servo before it completely loses power.

Decreased Steering Sensitivity (Negative Exponential):

By turning the Multi-Function knob clockwise, the steering sensitivity of the model will be decreased. Note that a relatively large amount of steering wheel travel results in a smaller amount of servo travel. The farther you turn the knob, the more pronounced the effect becomes. Decreased steering sensitivity may be helpful

when driving on low-traction surfaces, when driving at high speed, or on tracks that favor sweeping turns where gentle steering inputs are required. The ranges are exaggerated for illustrative purposes.

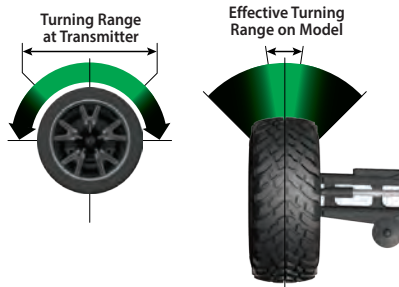

Throttle Sensitivity (Throttle Exponential)

The Multi-Function knob can be set to control Throttle Sensitivity. Throttle Sensitivity works the same way as Steering Sensitivity, but applies the effect to the throttle channel. Only forward throttle is affected; brake/reverse travel remains linear regardless of the Throttle Sensitivity setting.

Steering Percentage (Dual Rate)

The Multi-Function knob can be set to control the amount (percentage) of servo travel applied to steering. Turning the Multi-Function knob fully clockwise will deliver maximum steering throw; turning the knob counterclockwise reduces steering throw (note: turning the dial counterclockwise to its stop will eliminate all servo travel). Be aware that the steering End Point settings define the servo's maximum steering throw. If you set Steering Percentage to 100% (by turning the Multi-Function knob fully clockwise), the servo will travel all the way to its selected end point, but not past it. Many racers set Dual Rate so they have only as much steering throw as they need for the track's tightest turn, thus making the car easier to drive throughout the rest of the course. Reducing steering throw can also be useful in making a car easier to control on high-traction surfaces, and limiting steering output for oval racing where large amounts of steering travel are not required.

Steering and Throttle End Points

The TQi transmitter allows you to choose the limit of the servo's travel range (or its "end point") independently for left and right travel (on the steering channel) and throttle/brake travel (on the throttle channel). This allows you to fine-tune the servo settings to prevent binding caused by the servo moving steering or throttle linkages (in the case of a nitro car) farther than their mechanical limits. The end point adjustment settings you select will represent what you wish to be the servo's maximum travel; the Steering Percentage or Braking Percentage functions will not override the End Point settings.

Steering and Throttle Sub-Trim

The Sub-Trim function is used to precisely set the neutral point of the steering or throttle servo in the event that simply setting the trim knob to "zero" does not completely center the servo. When selected, Sub-Trim allows finer adjustment to the servo output shaft's position for precise setting of the neutral point. Always set the Steering Trim knob to zero before making final adjustment (if required) using Sub-Trim. If Throttle Trim has been previously adjusted, the Throttle Trim will need to be reprogrammed to "zero" before making final adjustment using Sub-Trim.

Braking Percentage

The Multi-Function knob may also be set to control the amount of brake travel applied by the servo in a nitro-powered model. Electric models do not have a servo-operated brake, but the Braking Percentage function still operates the same way in electric models. Turning the Multi-Function knob full clockwise will deliver maximum brake throw; turning the knob counterclockwise reduces brake throw (**Note:** Turning the dial counterclockwise to its stop will eliminate all brake action).

Throttle Trim

Setting the Multi-Function knob to serve as throttle trim will allow you to adjust the throttle's neutral position to prevent unwanted brake drag or throttle application when the transmitter trigger is at neutral. **Note:** Your transmitter is equipped with a Throttle Trim Seek mode to prevent accidental runaways. See the sidebar on page 34 for more information.

Setting Lock

Once you've adjusted all of these settings the way you like them, you may want to disable the Multi-Function knob so none of your settings can be changed. This is especially handy if you operate multiple vehicles with a single transmitter via Traxxas Link™ Model Memory.

Multiple Settings and the Multi-Function Knob

It is important to note that settings made with the Multi-Function knob are "overlaid" on top of each other. For example, if you assign the Multi-Function knob to adjust Steering Percentage and set it for 50%, then reassign the knob to control Steering Sensitivity, the transmitter will "remember" the Steering Percentage setting. Adjustments you make to Steering Sensitivity will be applied to the 50% steering throw setting you selected previously. Likewise, setting the Multi-Function knob to "disabled" will prevent the knob from making further adjustments, but the last setting of the Multi-Function knob will still apply.

TRAXXAS LINK MODEL MEMORY

Traxxas Link Model Memory is an exclusive, patent-pending feature of the TQi transmitter. Each time the transmitter is bound to a new receiver, it saves that receiver in its memory along with all the settings assigned to that receiver. When the transmitter and any bound receiver are switched on, the transmitter automatically recalls the settings for that receiver. There is no need to manually select your vehicle from a list of model memory entries.

Model Lock

The Traxxas Link Model Memory feature can store up to thirty models (receivers) in its memory. If you bind a thirty-first receiver, Traxxas Link Model Memory will delete the "oldest" receiver from its memory (in other words, the model you used the longest time ago will be deleted). Activating Model Lock will lock the receiver in memory so it cannot be deleted.

You may also bind multiple TQi transmitters to the same model, making it possible to pick up any transmitter and any previously bound model in your collection and simply turn them on and drive. With Traxxas Link Model Memory, there is no need remember which transmitter goes with which model and there is never a need to have to select any model from a list of model memory entries. The transmitter and receiver do it all for you automatically.

To activate Model Lock:

1. Switch on the transmitter and receiver you wish to lock.
2. Press and hold MENU. Release when the status LED blinks green.
3. Press MENU three times. The status LED will blink green four times repeatedly.
4. Press SET. The status LED will blink green in single-flash intervals.
5. Press SET once. The status LED will blink red once repeatedly.
6. Press MENU once. The LED will blink red twice repeatedly.
7. Press SET. The LED will blink rapidly green. The memory is now locked. Press MENU and SET to return to driving mode.

Note: To unlock a memory, press SET twice at step 5. The LED will blink rapidly green to indicate the model is unlocked. To unlock all models, press MENU twice at step 6 and then press SET.

To delete a model:

At some point, you may wish to delete a model you no-longer drive from the memory.

1. Switch on the transmitter and receiver you wish to delete.
2. Press and hold MENU. Release when the status LED blinks green.
3. Press MENU three times. The status LED will blink green four times repeatedly.
4. Press SET once. The status LED will blink green once repeatedly.
5. Press MENU once. The status LED will blink green twice repeatedly.
6. Press SET. The memory is now selected to be deleted. Press SET to delete the model. Press and hold MENU to return to driving mode.

MENU TREE

The Menu Tree below shows how to navigate through the TQi transmitter's various settings and functions. Press and hold MENU to enter the Menu Tree, and use the following commands to navigate through the menu and select options.

MENU: When you enter a menu, you always start at the top. Press MENU to move down the Menu Tree. When you reach the bottom of the tree, pressing MENU again will return you to the top.

SET: Press SET to move across the Menu Tree and select options. When an option is committed to the transmitter's memory, the status LED will rapidly blink green.

BACK: Press both MENU and SET to go back one level in the Menu Tree.

EXIT: Press and hold MENU to exit programming. Your selected options will be saved.

ECHO: Press and hold SET to activate the "echo" function. Echo will "play back" your current position on the Menu Tree. For example: If your current position is Steering Channel End Points, holding SET will cause the LED to blink green twice, green once, and then red three times. Echo will not alter your adjustments or change your position in the programming sequence.

Below is an example of how to access a function in the Menu Tree. In the example, the user is setting the Multi-Function knob to be a Steering % (Dual-Rate) control.

- To set the Multi-Function knob to control STEERING % (DUAL-RATE):

 1. Switch the transmitter on.
 2. Press and hold MENU until the green LED lights. It will blink in single intervals.
 3. Press SET. The red LED will blink in single intervals to indicate Steering Sensitivity (Expo) has been selected.
 4. Press MENU twice. The red LED will blink three times repeatedly to indicate Steering % (Dual-Rate) has been selected.
 5. Press SET to select. The green LED will blink 8 times fast to indicate successful selection.
 6. Press and hold MENU to return to driving mode.

Restoring Factory Defaults:

Transmitter OFF	Hold both MENU and SET	Transmitter ON	Release MENU and SET red LED blinks	Press SET to clear settings. LED will turn solid green. Transmitter is restored to default
-----------------	------------------------	----------------	--	--

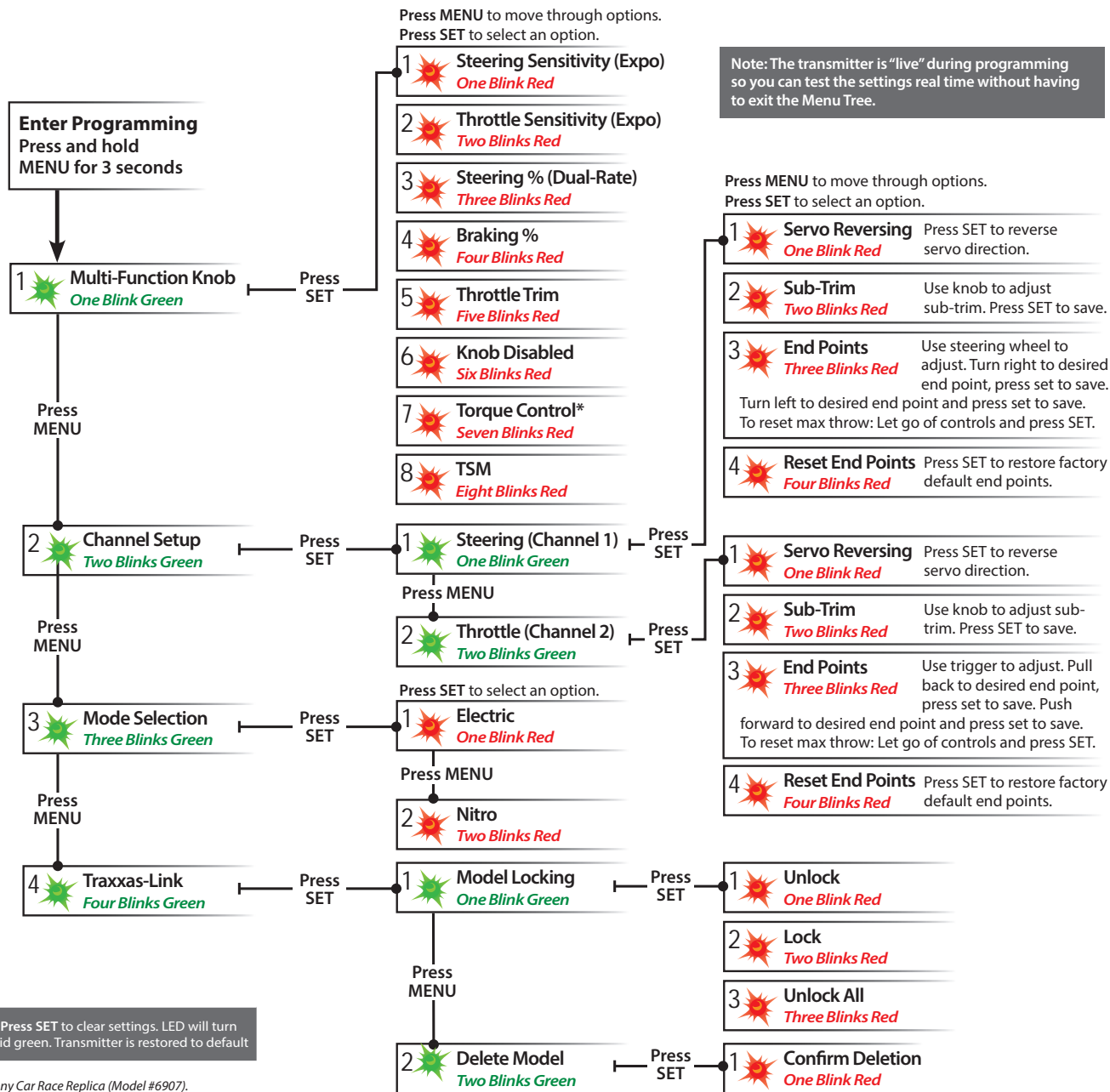

*Torque Control is a feature designed only for use with the power system in the Traxxas Funny Car Race Replica (Model #6907).

Set Multi-Function knob for STEERING SENSITIVITY (Expo)	Press/hold MENU green LED blinks	Press SET red LED blinks	x8 Press SET to confirm green LED blinks (x8)	Press/hold MENU returns to driving mode		
Set Multi-Function knob for THROTTLE SENSITIVITY (Expo)	Press/hold MENU green LED blinks	Press SET red LED blinks	x2 Press MENU to confirm red LED blinks (x2)	x8 Press SET to select green LED blinks (x8)	Press/hold MENU returns to driving mode	
Set Multi-Function knob for STEERING DUAL RATE (%)	Press/hold MENU green LED blinks	Press SET red LED blinks	x3 Press MENU twice red LED blinks (x3)	x8 Press SET to select green LED blinks (x8)	Press/hold MENU returns to driving mode	
Set Multi-Function knob for BRAKING PERCENTAGE (%)	Press/hold MENU green LED blinks	Press SET red LED blinks	x4 Press MENU 3 times red LED blinks (x4)	x8 Press SET to select green LED blinks (x8)	Press/hold MENU returns to driving mode	
Set Multi-Function knob for THROTTLE TRIM	Press/hold MENU green LED blinks	Press SET red LED blinks	x5 Press MENU 4 times red LED blinks (x5)	x8 Press SET to select green LED blinks (x8)	Press/hold MENU returns to driving mode Adjust the Multi-Function knob until the LED turns solid green.	
To LOCK the Multi-Function knob	Press/hold MENU green LED blinks	Press SET red LED blinks	x6 Press MENU 5 times red LED blinks (x6)	x8 Press SET to lock green LED blinks (x8)	Press/hold MENU returns to driving mode	
To REVERSE the direction of STEERING servo	Press/hold MENU green LED blinks	x2 Press MENU green LED blinks (x2)	Press SET green LED blinks	Press SET red LED blinks	x8 Press SET to reverse servo direction	Press/hold MENU returns to driving mode
To set the SUB TRIM of the STEERING servo	Press/hold MENU green LED blinks	x2 Press MENU green LED blinks (x2)	Press SET green LED blinks	Press SET red LED blinks	x2 Press MENU red LED blinks (x2)	Use Multi-Function knob to set neutral x8 Press SET to save position Press/hold MENU returns to driving mode
To set the END POINTS of the STEERING servo	Press/hold MENU green LED blinks	x2 Press MENU green LED blinks (x2)	Press SET green LED blinks	Press SET red LED blinks	x3 Press MENU twice red LED blinks (x3)	Turn steering wheel to desired max left and right travel x8 Press SET to save each position Turn steering wheel to test settings IF END POINTS ARE OK: Press/hold MENU returns to driving mode IF END POINTS NEED TO BE CHANGED: Press SET and repeat steps 6-8
To reset the END POINTS of STEERING servo to defaults	Press/hold MENU green LED blinks	x2 Press MENU green LED blinks (x2)	Press SET green LED blinks	Press SET red LED blinks	x4 Press MENU 3 times red LED blinks (x4)	x8 Press SET to reset end points Press/hold MENU returns to driving mode
To REVERSE the direction of THROTTLE servo	Press/hold MENU green LED blinks	x2 Press MENU green LED blinks (x2)	Press SET green LED blinks	x2 Press MENU green LED blinks (x2)	Press SET red LED blinks	x8 Press SET to reverse servo direction Press/hold MENU returns to driving mode
To set the SUB TRIM of the THROTTLE servo	Press/hold MENU green LED blinks	x2 Press MENU green LED blinks (x2)	Press SET green LED blinks	x2 Press MENU green LED blinks (x2)	Press SET red LED blinks	x2 Press MENU red LED blinks (x2) Use Multi-Function knob to set neutral x8 Press SET to save position Press/hold MENU returns to driving mode
To set the END POINTS of the THROTTLE servo	Press/hold MENU green LED blinks	x2 Press MENU green LED blinks (x2)	Press SET green LED blinks	x2 Press MENU green LED blinks (x2)	Press SET red LED blinks	x3 Press MENU twice red LED blinks (x3) Use throttle trigger to set desired max throttle or brake Press SET to save Use trigger to test IF END POINTS ARE OK: Press/hold MENU returns to driving mode IF END POINTS NEED TO BE CHANGED: Press SET and repeat steps 7-9
To reset the END POINTS of THROTTLE servo to defaults	Press/hold MENU green LED blinks	x2 Press MENU green LED blinks (x2)	Press SET green LED blinks	x2 Press MENU green LED blinks (x2)	Press SET red LED blinks	x4 Press MENU 3 times red LED blinks (x4) x8 Press SET green LED blinks (x8) Press/hold MENU returns to driving mode

MENU TREE FORMULAS

To select functions and make adjustments to the TQi transmitter without referencing the menu tree, turn your transmitter on, find the function in the left column you wish to adjust, and simply follow the corresponding steps.



Always turn your transmitter on first.

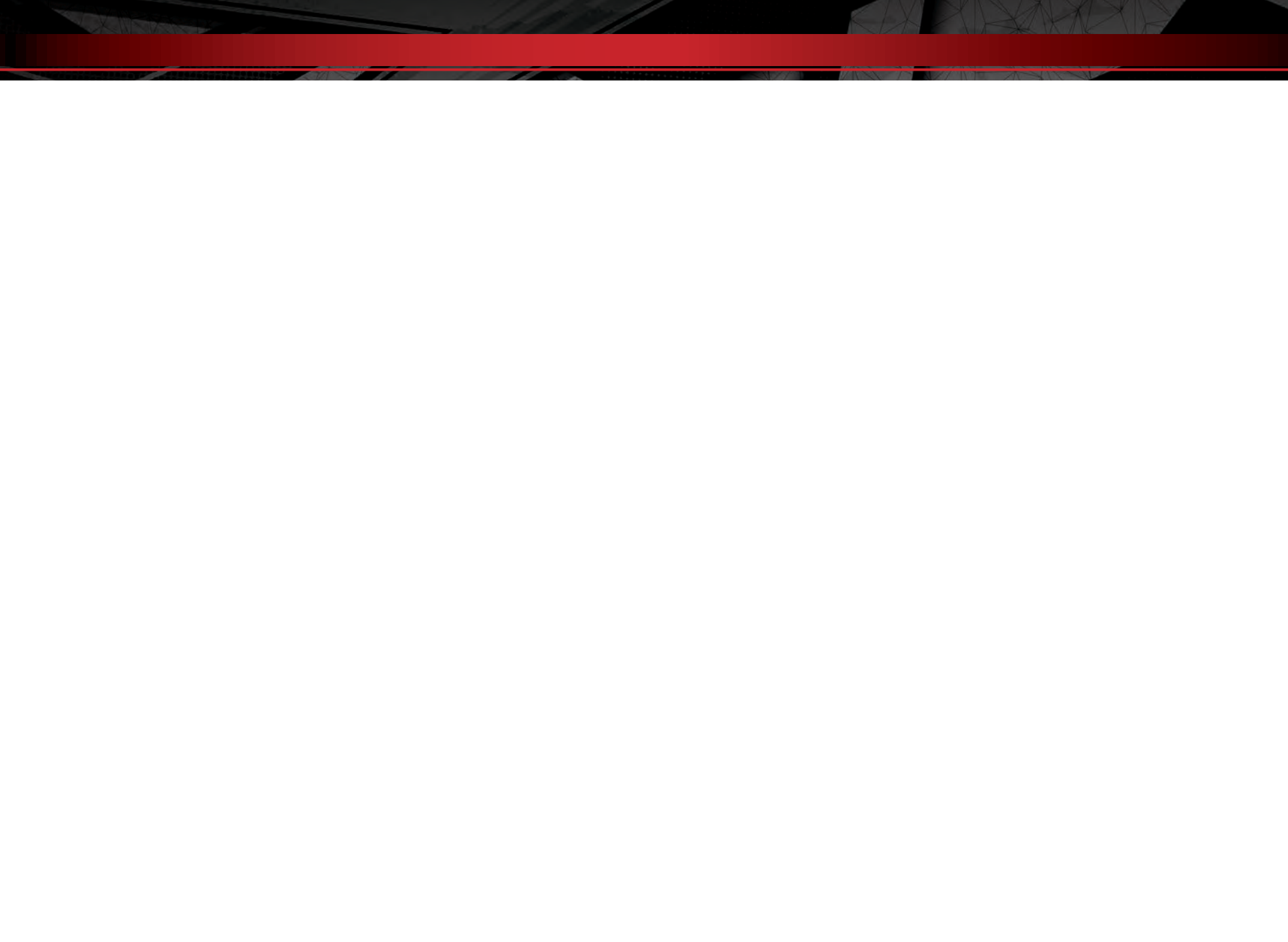

SLASH 4x4 ULTIMATE

OWNER'S MANUAL

TRAXXAS

6250 TRAXXAS WAY, MCKINNEY, TEXAS 75070

1-888-TRAXXAS